

# 2020

## **ANNUAL REPORT**

Year ended March 31, 2020



***Denyo Co., Ltd.***

# Profile

Since its establishment in **1948**, Denyo has been a pioneer in outdoor power sources, developing and manufacturing many original products, including engine-driven generators, engine-driven welders and engine-driven air compressors. Without contenting ourselves with our current market position or technical expertise, we have boldly taken on new R&D challenges and, as a result, we now command a 65% share of the domestic market for engine-driven generators, our main product. The Denyo Group comprises the Company and its eleven subsidiaries and one affiliate, along with its production facilities in Southeast Asia and the U.S., and R&D center in Japan.

## Contents

<b>Consolidated</b> Financial Highlights	1
<b>To</b> Our Shareholders	2
<b>Review</b> of Operations	4
<b>Overview</b> of Product Segment	6
<b>Consolidated</b> Financial Statements	7
<b>Financial</b> Review	8
<b>Independent</b> Auditor's Report	31
<b>Company</b> Data	32
<b>Investor</b> Information	36

## Establishment of Denyo Trading Vietnam Co., Ltd.



Inside the DTV office



Generators sold by DTV

Denyo established Denyo Trading Vietnam Co., Ltd. (DTV), a new sales subsidiary, in Hanoi, Vietnam in February 2020 as a wholly-owned subsidiary, and it commenced business in April.

DTV will actively develop operations in Vietnam, where economic development is remarkable, in cooperation with Denyo Vietnam Co., Ltd. (DVC), a local manufacturing plant.

# Consolidated Financial Highlights

	Millions of Yen			Thousands of U.S. Dollars
	2020	2019	2018	2020
Net Sales .....	¥62,887	¥55,554	¥50,182	\$577,847
Total Assets .....	75,626	74,086	72,210	694,904
Total Net Assets .....	58,354	56,291	56,133	536,195
Operating Income .....	6,058	4,201	3,902	55,665
Net Income* .....	4,071	3,167	2,762	37,411
<b>Per Share Data</b>		<b>Yen</b>		<b>U.S. Dollars</b>
Total Net Assets .....	¥2,689.54	¥2,583.90	¥2,545.17	\$24.71
Net Income* .....	194.32	149.83	130.03	1.79
Cash Dividends .....	46.00	42.00	40.00	0.42

Note: Transaction into U.S. dollars has been made, solely for the reader's convenience, at the rate of ¥108.83 to U.S.\$1, prevailing on the Tokyo Foreign Exchange Market on March 31, 2020.

## Net Sales

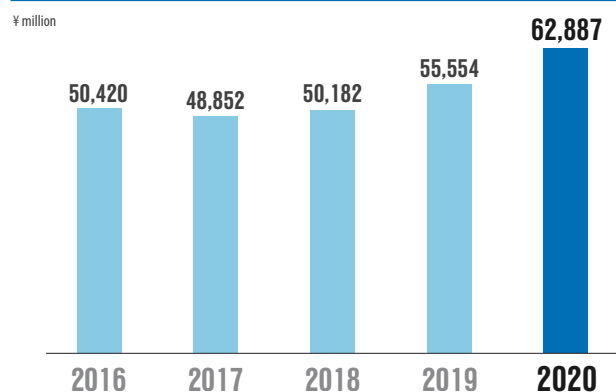

## Net Income\*

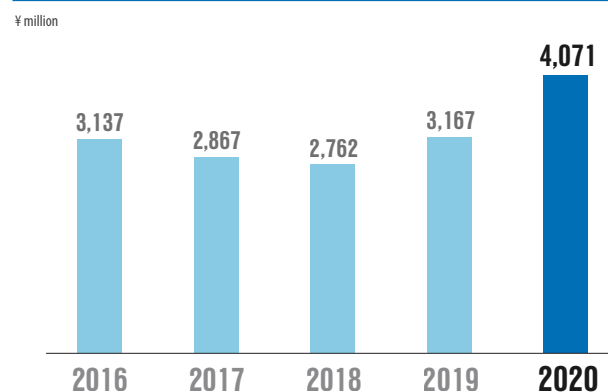

\* Net Income attributable to owners of the parent.

## Total Assets

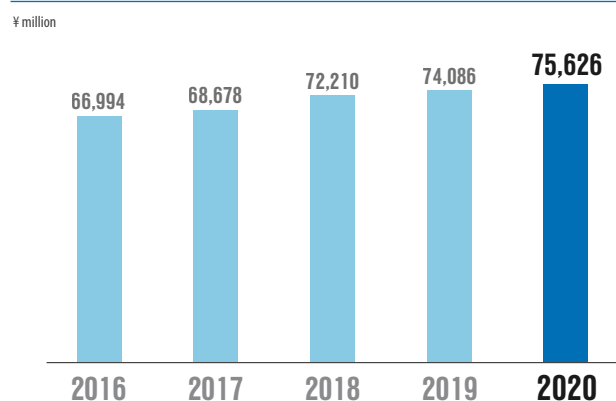

## Total Net Assets

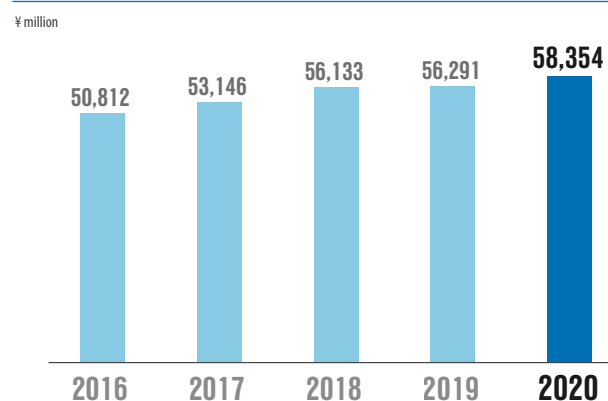



**TO  
OUR  
SHAREHOLDERS**  
** Denyo Co.,Ltd.**

Shoichi Shiratori, President

**In fiscal 2020** (ended March 31, 2020), the Japanese economy remained on a moderate recovery trend against a backdrop of improvements in the employment and income situations. On the other hand, the outlook for the global economy has become uncertain, given concerns over prolonged economic stagnation due to COVID-19, which began toward the end of the period, in addition to trade conflict between the United States and China.

In terms of the business environment surrounding the Denyo Group, construction demand remained solid in Japan thanks to construction for redevelopment projects in the Tokyo Metropolitan area, disaster prevention and disaster mitigation work. Demand for emergency generators also increased partly due to the natural disasters that have successively occurred in recent years. Overseas, demand remained high in the U.S. market.

Under these circumstances, the Denyo Group launched many new products onto the market and worked to improve production systems. As a result, both sales and income increased significantly, with consolidated net sales rising to ¥62,887 million (US\$577,847 thousand), up 13.2% year on year, consolidated operating income increasing to ¥6,058 million (US\$55,665 thousand), a rise of 44.2% year on year, consolidated ordinary income climbing to ¥6,203 million (US\$56,997 thousand), up 35.1% year on year, and net income attributable to owners of the parent increasing 28.6% year on year to ¥4,071 million (US\$37,411 thousand). The Group recorded share of loss of entities accounted for using the equity method of ¥108 million (US\$989 thousand) as a result of posting allowance for doubtful accounts for overdue accounts receivable at associated companies.

Regarding dividends for the fiscal year under review, we issued an interim dividend of ¥22 (US\$0.20) per share and decided to pay an ordinary year-end dividend of ¥24 (US\$0.22) per share. As a result, dividends for the full year came to ¥46 (US\$0.42) per share (an increase of ¥4 (US\$0.04) from the previous fiscal year).

The future outlook is uncertain, given that COVID-19 continues to spread in countries around the world and is having a significant impact on economic activities in Japan and overseas.

Under these conditions, the Denyo Group will steadily implement a range of measures in the final year of its Denyo 2020 medium-term management plan while continuously paying all due attention to COVID-19, making the safety and health of its customers, business partners and employees its first priority.

We would like to respectfully ask our shareholders for their continued patronage and support.

June 2020



Shoichi Shiratori, President

# Review of Operations

## (1) Engagement in fuel-cell portable generators and electric generator trucks

Denyo has decided to work on the technology development and demonstration program for fuel-cell portable generator and electric generator truck jointly with other companies because Denyo was selected by the Low Carbon Technology Research, Development and Demonstration Program of the Ministry of the Environment of Japan.

Given the commencement of the general sale of fuel cell vehicles (FCV) and the development of hydrogen refueling stations supplying hydrogen, a fuel for FCV, Denyo has decided to work on the development and demonstration of fuel-cell portable generators and electric generator trucks as the leading manufacturer of mobile-type generators, believing that this will lead to future measures addressing global warming.

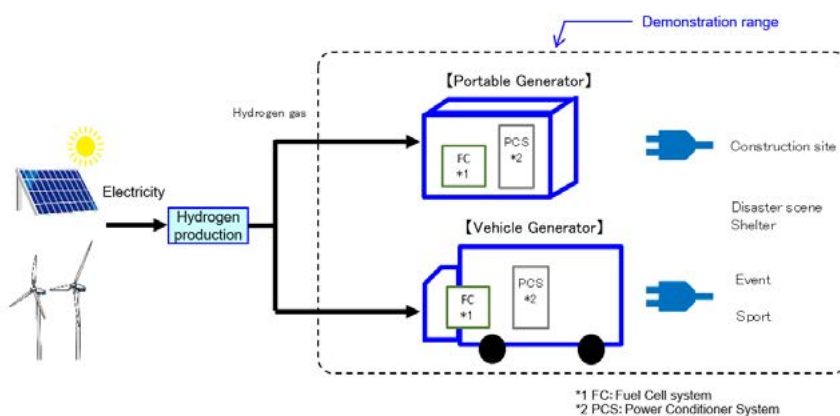

Denyo will contribute to the reduction of CO<sub>2</sub> emissions by developing and demonstrating fuel cell systems for mobile-type generators and electric generator trucks able to use hydrogen manufactured from electricity generated using renewable energy such as solar or wind power, as well as power conditioners compatible with various loading apparatuses.

## (2) Introduction of ultra-low noise emergency generators

Denyo focuses on the development and sale of emergency generators together with Nishihatsu Co., Ltd., a Group company.

Depending on the location's intended use and size, disaster preparedness equipment including sprinklers and fire hydrant pumps, are installed in buildings used by large numbers of the general public, such as department stores, hotels, hospitals and underground malls, to be used in an emergency.

A great number of Denyo emergency generators are used to provide emergency power to this equipment.

Ultra-low noise emergency generators, which combine the technical capabilities cultivated by Nishihatsu over many years in private emergency generators and the noise insulation package technology developed by Denyo in the DCA-US series of ultra-low noise generator, have a noise level of 65dB at a distance of 1 meter. They are so quiet that people standing a moderate distance away can be unaware that they are operating.

They are optimal products for customers who need to pay particular attention to noise, such as hospitals, nursing-care facilities, hotels, and facilities in residential areas.



### (3) Introduction of **DCW-500LSE,** a CO<sub>2</sub> arc engine-driven welding machine



Denyo developed DCW-500LSE, a 500A CO<sub>2</sub> arc engine-driven welding machine, and began selling it in July 2019.

Denyo developed the industry's first 350A CO<sub>2</sub> arc engine-driven welding machine more than 35 years ago, and to date it has developed a good reputation for its high welding performance.



The DCW-500LSE has further improved welding performance with its inverter welding control, and its maximum welding current has also increased from 350A to 500A. 500A output is possible in all CO<sub>2</sub> arc welding modes, manual welding and gouging, and operations that could not previously be conducted by conventional engine-driven welding machines are extensively enabled, contributing to the improvement of operations to make them faster and more efficient.

<b>Max current 500A in 3 modes!</b>				<b>+</b>	<b>AC Power</b>	
					<b>Three-Phase 25 kVA</b>	<b>Single-Phase 9.9 kVA</b>
	<b>CO<sub>2</sub> arc welding</b>	<b>Manual welding</b>	<b>Gouging</b>			

The alternating-current (AC) output has also increased significantly, with three-phase AC 25kVA and single-phase AC 9.9kVA now available. The DCW-500LSE can be used in a wide range of applications, including shipbuilding, bridge work and heavy machine maintenance.

As the pioneer of engine-driven welding machines, Denyo will continue to develop new engine-driven welding machines that meet customers' expectations.

# Overview of Product Segment

Business performance by product category and domestic market share

## Engine Generators

In the engine generators segment, shipments of mobile-type generators used mainly on construction sites calmed down in Japan, but shipments of emergency generators, such as gas-fueled generators, that are used as a back-up power source in a power outage increased.

Overseas, while shipments to Asia remained sluggish, shipments to the U.S. remained strong. As a result, segment sales rose to ¥50,436 million (US\$463,442 thousand), up 15.5% year on year.

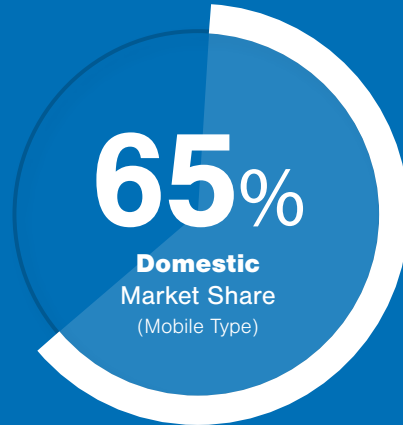

## Engine Welders

In the engine welders segment, shipments of special welders such as CO<sub>2</sub> welding machines and TIG welding machines increased in Japan, but shipments to the U.S. decreased. As a result, segment sales declined to ¥5,073 million (US\$46,610 thousand), a fall of 0.8% year on year.

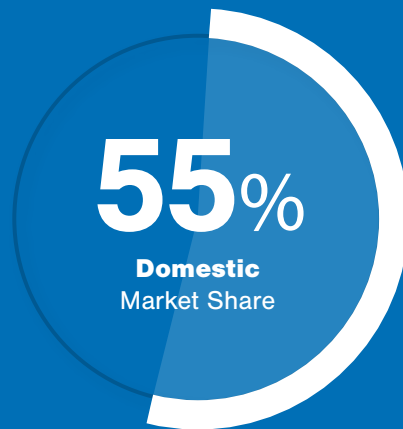

## Compressors

In the compressors segment, while shipments to the U.S. increased, shipments in Japan remained weak. As a result, segment sales declined to ¥1,013 million (US\$9,304 thousand), down 4.5% year on year.



## Other Products

In the other products segment, sales were ¥6,366 million (US\$58,492 thousand), up 11.3% from the previous fiscal year, thanks mainly to an increase in sales of self-propelled lifters and parts attached to products.

Note: Above domestic share is five year mean by our investigation



# **Denyo Co., Ltd.** and Subsidiaries

Consolidated Financial Statements  
for the Year Ended March 31, 2020,  
and Independent Auditor's Report

# Financial Review

## Business Environment and Results

In fiscal 2020 (ended March 31, 2020), the Japanese economy remained on a moderate recovery trend against a backdrop of improvements in the employment and income situations. On the other hand, the outlook for the global economy has become uncertain, given concerns over prolonged economic stagnation due to COVID-19, which began toward the end of the period, in addition to trade conflict between the United States and China.

In terms of the business environment surrounding the Denyo Group, construction demand remained solid in Japan thanks to construction for redevelopment projects in the Tokyo Metropolitan area, disaster prevention and disaster mitigation work. Demand for emergency generators also increased partly due to the natural

disasters that have successively occurred in recent years. Overseas, demand remained high in the U.S. market.

Under these circumstances, the Denyo Group launched many new products onto the market and worked to improve production systems. As a result, both sales and income increased significantly, with consolidated net sales rising to ¥62,887 million (US\$577,847 thousand), up 13.2% year on year, consolidated operating income increasing to ¥6,058 million (US\$55,665 thousand), a rise of 44.2% year on year, consolidated ordinary income climbing to ¥6,203 million (US\$56,997 thousand), up 35.1% year on year, and net income attributable to owners of the parent increasing 28.6% year on year to ¥4,071 million (US\$37,411 thousand).

## Segment Information

In the engine generators segment, shipments of mobile-type generators used mainly on construction sites calmed down in Japan, but shipments of emergency generators, such as gas-fueled generators, that are used as a back-up power source in a power outage increased. Overseas, while shipments to Asia remained sluggish, shipments to the U.S. remained strong. As a result, segment sales rose to ¥50,436 million (US\$463,442 thousand), up 15.5% year on year.

In the engine welders segment, shipments of special welders such as CO<sub>2</sub> welding machines and TIG welding machines increased in Japan, but shipments to the U.S. decreased. As a result, segment sales declined to ¥5,073 million (US\$46,610 thousand), a fall of 0.8% year on year.

In the compressors segment, while shipments to the U.S. increased, shipments in Japan remained weak. As a result, segment sales declined to ¥1,013 million (US\$9,304 thousand), down 4.5% year on year.

In the other products segment, sales were ¥6,366 million (US\$58,492 thousand), up 11.3% from the previous fiscal year, thanks mainly to an increase in sales of self-propelled lifters and parts attached to products.

Information by geographical area is as follows.

### (Japan)

In Japan, while shipments of generators to the rental market calmed down, shipments of emergency generators remained strong against a backdrop of a rising awareness of disaster preparedness. Exports of large

generators to the U.S. also increased. As a result, sales rose to ¥43,626 million (US\$400,860 thousand), up 7.2% year on year, and segment profit increased to ¥3,396 million (US\$31,209 thousand), up 38.9% year on year.

### (U.S.)

In the U.S., shipments of generators to our core rental market increased significantly on the back of the strong economy. As a result, sales increased to ¥15,167 million (US\$139,368 thousand), up 39.2% year on year, and segment profit rose to ¥1,169 million (US\$10,739 thousand), up 54.7% year on year.

### (Asia)

In Asia, shipments of generators for transportation infrastructure projects such as subways increased, and sales increased to ¥3,585 million (US\$32,941 thousand), up 8.2% year on year. Segment profit also rose to ¥793 million (US\$7,287 thousand), up 27.8% year on year, thanks in part to an improved cost-to-sales ratio at the plant in Vietnam.

### (Europe)

In Europe, the last-minute demand ahead of the new emission control regulations that came into force in the previous fiscal year cooled down, resulting in a fall in sales to ¥509 million (US\$4,678 thousand), down 20.0% year on year. However, segment profit rose to ¥37 million (US\$342 thousand), up 29.2% year on year, due partly to the improved cost-to-sales ratio.

## Financial Position

### (Assets)

Total assets at the end of the fiscal year under review were ¥75,626 million (US\$694,904 thousand), an increase of ¥1,541 million (US\$14,157 thousand) from the end of the previous fiscal year.

Current assets at the end of the fiscal year under review were ¥52,932 million (US\$486,375 thousand), an increase of ¥3,083 million (US\$28,330 thousand) from the end of the previous fiscal year. This was mainly due to an increase in cash and deposits of ¥4,865 million

### Net Income per Share

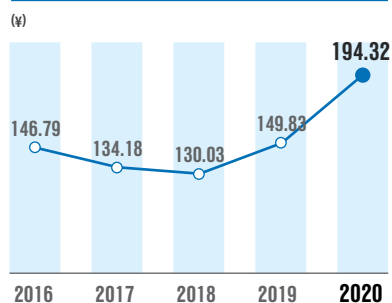

### Cash Dividends per Share

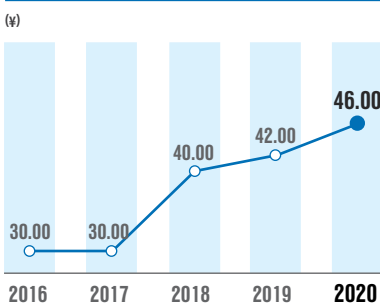

### Equity Ratio

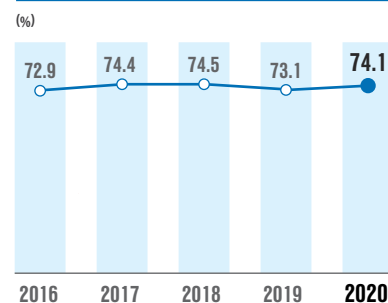

(US\$44,703 thousand), a fall in notes and accounts receivable - trade of ¥1,266 million (US\$11,631 thousand), a decrease in electronically recorded monetary claims - operating of ¥373 million (US\$3,423 thousand) and an decrease in merchandise and finished products of ¥338 million (US\$3,109 thousand). Non-current assets at the end of the fiscal year under review were ¥22,694 million (US\$208,529 thousand), down ¥1,542 million (US\$14,173 thousand) from the end of the previous fiscal year. This mainly reflected a decrease in investment securities of ¥1,776 million (US\$16,316 thousand) due to the sale and revaluation of stockholdings.

#### (Liabilities)

Total liabilities at the end of the fiscal year under review were ¥17,272 million (US\$158,709 thousand), decreasing ¥523 million (US\$4,802 thousand) from the end of the previous fiscal year. Current liabilities at the end of the fiscal year under review were ¥14,253 million (US\$130,965 thousand), down ¥371 million (US\$3,411 thousand) from the end of the previous fiscal year. This was mainly due to a decrease in trade notes and accounts payable - trade of ¥408

million (US\$3,746 thousand) and a fall in short-term loans of ¥222 million (US\$2,038 thousand). Non-current liabilities at the end of the fiscal year under review were ¥3,019 million (US\$27,744 thousand), down ¥151 million (US\$1,391 thousand) from the end of the previous fiscal year. This was mainly due to an increase in lease obligations of ¥282 million (US\$2,591 thousand) as a result of the application of IFRS 16 Leases at some overseas consolidated subsidiaries and a fall in deferred tax liabilities of ¥362 million (US\$3,330 thousand).

#### (Net assets)

Net assets at the end of the fiscal year under review were ¥58,354 million (US\$536,195 thousand), an increase of ¥2,063 million (US\$18,959 thousand) from the end of the previous fiscal year. This was mainly due to net income attributable to owners of the parent of ¥4,071 million (US\$37,411 thousand), an ¥889 million (US\$8,168 thousand) fall in the valuation difference on available-for-sale securities, cash dividends paid of ¥959 million (US\$8,813 thousand), and the purchase of treasury shares of ¥276 million (US\$2,539 thousand).

## Cash Flows

Consolidated cash and cash equivalents (hereinafter, cash) were ¥21,054 million (US\$193,460 thousand) at the end of the fiscal year under review, increasing ¥4,883 million (US\$44,872 thousand) from the end of the previous fiscal year, largely due to income before income taxes of ¥6,178 million (US\$56,767 thousand).

#### (Cash flows from operating activities)

Net cash provided by operating activities was ¥7,272 million (US\$66,826 thousand) (cash provided of ¥4,085 million (US\$37,536 thousand) in the previous fiscal year). This was largely due to income before income taxes of ¥6,178 million (US\$56,767 thousand), depreciation of ¥1,162 million (US\$10,676 thousand), a decrease in trade notes and accounts receivable of ¥1,608 million (US\$14,772 thousand), and a fall in trade notes and accounts payable of ¥546 million (US\$5,012 thousand).

#### (Cash flows from investing activities)

Net cash used in investing activities was ¥874 million (US\$8,033 thousand) (cash used of ¥164 million (US\$1,508 thousand) in the previous fiscal year). This largely reflected the purchase of property, plant and equipment of ¥1,250 million (US\$11,486 thousand) and proceeds from sales of investment securities of ¥390 million (US\$3,585 thousand).

#### (Cash flows from financing activities)

Net cash used in financing activities was ¥1,528 million (US\$14,042 thousand) (cash used of ¥1,316 million (US\$12,092 thousand) in the previous fiscal year). This was mainly due to a decrease in short-term loans of ¥218 million (US\$2,007 thousand), the purchase of treasury shares of ¥276 million (US\$2,539 thousand) and dividends paid of ¥959 million (US\$8,813 thousand).

## Dividends

Denyo recognizes the importance of making further efforts to return profits to shareholders while also investing in equipment and research & development to enhance and maintain product competitiveness and striving to improve profitability and strengthen its financial structure. Our policy is to distribute profits based on the comprehensive consideration of a wide range of factors including business performance and the payout ratio.

Regarding dividends for the fiscal year under review, we issued an interim dividend of ¥22 (US\$0.20) per share and decided to pay an ordinary year-end dividend of ¥24 (US\$0.22) per share based on the policy above. As a result, dividends for the full year came to ¥46 (US\$0.42) per share (an increase of ¥4 (US\$0.04) from the previous fiscal year). As a consequence, the dividend payout ratio (consolidated) for the fiscal year under review came to 23.7%.

### Return on Average Shareholders' Equity

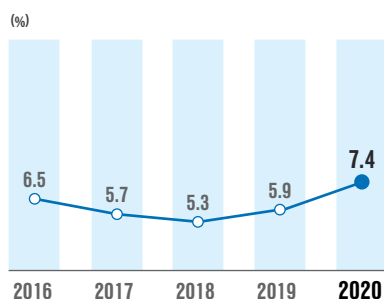

### Return on Average Assets (ROA)

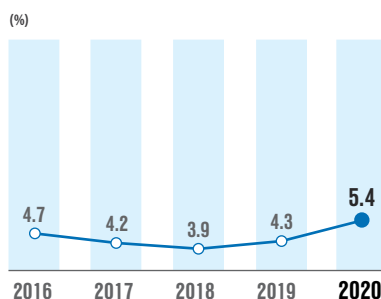

### Price Earnings Ratio

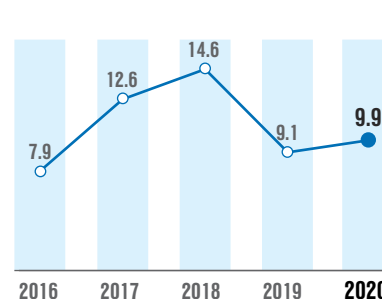

# Consolidated Balance Sheet

DENYO CO., LTD. AND SUBSIDIARIES · YEAR ENDED MARCH 31, 2020

ASSETS	Millions of Yen		Thousands of U.S. Dollars (Note 1)
	2020	2019	2020
<b>CURRENT ASSETS:</b>			
Cash and cash equivalents (Note 16) .....	¥21,054	¥16,171	\$193,460
Time deposits other than cash equivalents (Note 16) .....		18	
Receivables (Note 16):			
Trade notes (Note 2.w) .....	3,997	5,679	36,730
Electronically recorded monetary claims—operating (Note 2.w) .....	2,922	3,294	26,849
Trade accounts .....	12,401	10,889	113,947
Associated companies (Note 22) .....	1,795	2,891	16,493
Other .....	62	82	574
Allowance for doubtful receivables .....	(4)	(6)	(40)
Inventories (Note 6) .....	10,474	10,648	96,239
Prepaid expenses and other current assets .....	231	183	2,123
<b>Total current assets .....</b>	<b>52,932</b>	<b>49,849</b>	<b>486,375</b>
<b>PROPERTY, PLANT AND EQUIPMENT (Note 7):</b>			
Land .....	4,836	4,835	44,432
Buildings and structures .....	13,041	13,225	119,826
Machinery and equipment (Note 15) .....	7,477	7,240	68,707
Furniture and fixtures .....	1,969	1,899	18,103
Construction in progress .....	602	102	5,528
<b>Total .....</b>	<b>27,925</b>	<b>27,301</b>	<b>256,596</b>
Accumulated depreciation .....	(13,480)	(12,886)	(123,862)
<b>Net property, plant and equipment .....</b>	<b>14,445</b>	<b>14,415</b>	<b>132,734</b>
<b>INVESTMENTS AND OTHER ASSETS:</b>			
Investment securities (Notes 5 and 16) .....	6,518	8,164	59,889
Investments in associated companies (Note 8) .....	811	940	7,454
Deferred tax assets (Note 13) .....	172	175	1,579
Other assets .....	748	543	6,873
<b>Total investments and other assets .....</b>	<b>8,249</b>	<b>9,822</b>	<b>75,795</b>
<b>TOTAL .....</b>	<b>¥75,626</b>	<b>¥74,086</b>	<b>\$694,904</b>

See notes to consolidated financial statements.

LIABILITIES AND EQUITY	Millions of Yen		Thousands of U.S. Dollars (Note 1)
	2020	2019	2020
<b>CURRENT LIABILITIES:</b>			
Short-term bank loans (Notes 9 and 16).....	¥210	¥432	\$1,930
Current portion of long-term debt (Notes 9, 15 and 16).....	15	1	137
Payables (Note 16):			
Trade notes (Note 2.w).....	1,063	1,253	9,771
Electronically recorded obligations—operating (Note 2.w).....	1,986	2,146	18,248
Trade accounts.....	7,813	8,035	71,795
Associated companies.....	12	9	107
Other.....	201	233	1,850
Accrued income taxes (Note 13).....	1,062	539	9,761
Accrued expenses.....	1,261	1,382	11,591
Provision for product warranties.....	103	100	949
Other current liabilities.....	527	494	4,826
<b>Total current liabilities.....</b>	<b>14,253</b>	<b>14,624</b>	<b>130,965</b>
<b>LONG-TERM LIABILITIES:</b>			
Long-term debt (Notes 9, 15 and 16).....	1,371	1,111	12,597
Liability for retirement benefits (Note 11).....	434	433	3,987
Deferred tax liabilities (Note 13).....	961	1,323	8,827
Other long-term liabilities.....	253	304	2,333
<b>Total long-term liabilities.....</b>	<b>3,019</b>	<b>3,171</b>	<b>27,744</b>
<b>COMMITMENTS AND CONTINGENT LIABILITIES (Notes 15, 17 and 18)</b>			
<b>EQUITY (Note 12):</b>			
Common stock—authorized, 97,811,000 shares; issued, 22,859,660 shares in 2020 and 22,859,660 shares in 2019.....	1,955	1,955	17,962
Capital surplus.....	1,779	1,779	16,351
Retained earnings.....	51,903	48,794	476,917
Treasury stock—at cost, 2,014,745 shares in 2020 and 1,901,761 shares in 2019 (Note 4)...	(2,365)	(2,107)	(21,734)
Accumulated other comprehensive income:			
Unrealized gain on available-for-sale securities.....	2,575	3,464	23,665
Foreign currency translation adjustments.....	249	301	2,287
Defined retirement benefit plans.....	(33)	(33)	(302)
Total.....	56,063	54,153	515,146
Noncontrolling interests.....	2,291	2,138	21,049
<b>Total equity.....</b>	<b>58,354</b>	<b>56,291</b>	<b>536,195</b>
<b>TOTAL.....</b>	<b>¥75,626</b>	<b>¥74,086</b>	<b>\$694,904</b>

# Consolidated Statement of Income and Comprehensive Income

DENYO CO., LTD. AND SUBSIDIARIES · YEAR ENDED MARCH 31, 2020

	Millions of Yen		Thousands of U.S. Dollars (Note 1)
	2020	2019	2020
NET SALES (Notes 21 and 22).....	¥62,887	¥55,554	\$577,847
COST OF SALES.....	48,288	43,145	443,706
Gross profit.....	14,599	12,409	134,141
SELLING, GENERAL AND ADMINISTRATIVE EXPENSES (Note 14).....	8,541	8,208	78,476
Operating income.....	6,058	4,201	55,665
OTHER INCOME (EXPENSES):			
Interest and dividend income.....	248	222	2,283
Interest expense.....	(57)	(46)	(523)
Gain on sale of property, plant and equipment.....		4	
Loss on sale or disposal of property, plant and equipment.....	(40)	(12)	(371)
Loss on impairment of long-lived assets (Note 7).....		(108)	
Loss on revaluation of investment securities.....	(180)		(1,657)
Foreign exchange gain (loss) gain.....	(56)	20	(513)
Equity in earnings of associated companies.....	(108)	99	(989)
Rent income.....	80	78	738
Insurance claim income (Note 2.w).....	65	3	598
Commitment fee.....	(32)	(7)	(293)
Gain on sale of investment securities.....	196	121	1,797
Other—net.....	4	23	32
Other income—net.....	120	397	1,102
INCOME BEFORE INCOME TAXES.....	6,178	4,598	56,767
INCOME TAXES (Note 13):			
Current.....	1,895	1,265	17,414
Deferred.....	(2)	(24)	(17)
Total income taxes.....	1,893	1,241	17,397
NET INCOME.....	4,285	3,357	39,370
NET INCOME ATTRIBUTABLE TO:			
Owners of the parent.....	4,071	3,167	37,411
Noncontrolling interests.....	214	190	1,959
NET INCOME—(Forward).....	¥4,285	¥3,357	\$39,370
OTHER COMPREHENSIVE LOSS (Note 19):			
Unrealized loss on available-for-sale securities.....	(884)	(1,152)	(8,124)
Foreign currency translation adjustments.....	(54)	(533)	(492)
Defined retirement benefit plans.....	(0)	8	(0)
Share of other comprehensive loss in associates.....	(5)	(1)	(44)
Total other comprehensive loss.....	(943)	(1,678)	8,660
COMPREHENSIVE INCOME.....	¥3,342	¥1,679	\$30,710
TOTAL COMPREHENSIVE INCOME ATTRIBUTABLE TO:			
Owners of the parent.....	¥3,130	¥1,567	\$28,761
Noncontrolling interests.....	212	112	1,949
	Yen		U.S. Dollars
PER SHARE OF COMMON STOCK (Notes 2.t and 20):			
Basic net income.....	¥194.32	¥149.83	\$1.79
Cash dividends applicable to the year.....	46.00	42.00	0.42

See notes to consolidated financial statements.

# Consolidated Statement of Changes in Equity

DENYO CO., LTD. AND SUBSIDIARIES · YEAR ENDED MARCH 31, 2020

	Thousands		Millions of Yen								
	Number of Shares of Common Stock Outstanding	Common Stock	Capital Surplus	Retained Earnings	Treasury Stock	Accumulated Other Comprehensive Income				Noncontrolling Interests	Total Equity
						Unrealized Gain on Available-for-Sale Securities	Foreign Currency Translation Adjustments	Defined Retirement Benefit Plans	Total		
BALANCE, APRIL 1, 2018	21,243	¥1,955	¥1,779	¥46,622	¥(1,622)	¥4,617	¥756	¥(41)	¥54,066	¥2,067	56,133
Net income attributable to owners of the parent				3,167					3,167		3,167
Cash dividends, ¥42 per share				(995)					(995)		(995)
Purchase of treasury stock	(300)				(501)				(501)		(501)
Selling of treasury stock	15				16				16		16
Net change in the year						(1,153)	(455)	8	(1,600)	71	(1,529)
BALANCE, MARCH 31, 2019	20,958	1,955	1,779	48,794	(2,107)	3,464	301	(33)	54,153	2,138	56,291
Cumulative effect of accounting change				(3)					(3)		(3)
BALANCE, APRIL 1, 2019	20,958	1,955	1,779	48,791	(2,107)	3,464	301	(33)	54,150	2,138	56,288
Net income attributable to owners of the parent				4,071					4,071		4,071
Cash dividends, ¥46 per share				(959)					(959)		(959)
Purchase of treasury stock	(130)				(276)				(276)		(276)
Selling of treasury stock	17				18				18		18
Net change in the year						(889)	(52)		(941)	153	(788)
<b>BALANCE, MARCH 31, 2020</b>	<b>20,845</b>	<b>¥1,955</b>	<b>¥1,779</b>	<b>¥51,903</b>	<b>¥(2,365)</b>	<b>¥2,575</b>	<b>¥249</b>	<b>¥(33)</b>	<b>¥56,063</b>	<b>¥2,291</b>	<b>¥58,354</b>

Thousands of U.S. Dollars (Note 1)

	Thousands of U.S. Dollars (Note 1)									
	Common Stock	Capital Surplus	Retained Earnings	Treasury Stock	Accumulated Other Comprehensive Income				Noncontrolling Interests	Total Equity
					Unrealized Gain on Available-for-Sale Securities	Foreign Currency Translation Adjustments	Defined Retirement Benefit Plans	Total		
BALANCE, MARCH 31, 2019	\$17,962	\$16,351	\$448,343	\$(19,362)	\$31,832	\$2,769	\$(302)	\$497,593	\$19,642	\$517,235
Cumulative effect of accounting change			(24)					(24)		(24)
BALANCE, APRIL 1, 2019	17,962	16,351	448,319	(19,362)	31,832	2,769	(302)	497,569	19,642	517,211
Net income attributable to owners of the parent			37,411					37,411		37,411
Cash dividends, \$0.42 per share			(8,813)					(8,813)		(8,813)
Purchase of treasury stock				(2,539)				(2,539)		(2,539)
Selling of treasury stock				167				167		167
Net change in the year					(8,167)	(482)		(8,649)	1,407	(7,242)
<b>BALANCE, MARCH 31, 2020</b>	<b>\$17,962</b>	<b>\$16,351</b>	<b>\$476,917</b>	<b>\$(21,734)</b>	<b>\$23,665</b>	<b>\$2,287</b>	<b>\$(302)</b>	<b>\$515,146</b>	<b>\$21,049</b>	<b>\$536,195</b>

See notes to consolidated financial statements.

# Consolidated Statement of Cash Flows

DENYO CO., LTD. AND SUBSIDIARIES · YEAR ENDED MARCH 31, 2020

	Millions of Yen		Thousands of U.S. Dollars (Note 1)
	2020	2019	2020
<b>OPERATING ACTIVITIES:</b>			
Income before income taxes .....	¥6,178	¥4,598	\$56,767
Adjustments for:			
Income taxes paid .....	(1,387)	(1,211)	(12,743)
Depreciation and amortization .....	1,162	1,132	10,676
Loss on sale or disposal of property, plant and equipment—net .....	40	8	370
Gain on sale of investment securities .....	(196)	(121)	(1,797)
Loss on impairment of long-lived assets .....		108	
Equity in earnings of associated companies .....	108	(99)	989
Loss on revaluation of investment securities .....	180		1,657
Changes in assets and liabilities, net of effects:			
Decrease (increase) in trade notes and accounts receivable .....	1,608	(1,371)	14,772
Decrease (increase) in inventories .....	138	(995)	1,264
Decrease in interest and dividends receivable .....	13	19	115
(Decrease) increase in trade notes and accounts payable .....	(546)	1,972	(5,012)
Decrease in provision for allowance for doubtful accounts .....	(3)	(1)	(30)
Decrease in liability for retirement benefits .....	(2)	(32)	(15)
Other—net .....	(21)	78	(187)
Total adjustments .....	1,094	(513)	10,059
Net cash provided by operating activities .....	7,272	4,085	66,826
<b>INVESTING ACTIVITIES:</b>			
Purchases of property, plant and equipment .....	(1,250)	(1,489)	(11,486)
Purchases of securities .....	(3)	(3)	(25)
Proceeds from sales of securities .....	390	266	3,585
Investment in loans receivable .....	(1)	(7)	(13)
Collections of loans receivable .....	5	7	48
Decrease in time deposit—net .....	18	1,112	166
Other—net (Note 2.w) .....	(33)	(50)	(308)
Net cash used in investing activities .....	(874)	(164)	(8,033)
<b>FINANCING ACTIVITIES:</b>			
(Decrease) increase in short-term loans—net .....	(218)	221	(2,007)
Purchases of treasury stock .....	(276)	(501)	(2,539)
Dividends paid .....	(959)	(994)	(8,813)
Other—net .....	(75)	(42)	(683)
Net cash used in financing activities .....	(1,528)	(1,316)	(14,042)
FOREIGN CURRENCY TRANSLATION ADJUSTMENTS ON CASH AND CASH EQUIVALENTS ..	13	(147)	121
NET INCREASE IN CASH AND CASH EQUIVALENTS—(Forward) .....	¥4,883	¥2,458	\$44,872
CASH AND CASH EQUIVALENTS, BEGINNING OF YEAR .....	16,171	13,713	148,588
CASH AND CASH EQUIVALENTS, END OF YEAR .....	¥21,054	¥16,171	\$193,460

See notes to consolidated financial statements.



# Notes to Consolidated Financial Statements

DENYO CO., LTD. AND SUBSIDIARIES · YEAR ENDED MARCH 31, 2020

## 1. BASIS OF PRESENTATION OF CONSOLIDATED FINANCIAL STATEMENTS

The accompanying consolidated financial statements have been prepared in accordance with the provisions set forth in the Japanese Financial Instruments and Exchange Act and its related accounting regulations and in accordance with accounting principles generally accepted in Japan ("Japanese GAAP"), which are different in certain respects as to the application and disclosure requirements of International Financial Reporting Standards.

In preparing these consolidated financial statements, certain reclassifications and rearrangements have been made to the consolidated financial statements issued domestically in order to

present them in a form which is more familiar to readers outside Japan.

The consolidated financial statements are stated in Japanese yen, the currency of the country in which Denyo Co., Ltd. (the "Company") is incorporated and operates. The translations of Japanese yen amounts into U.S. dollar amounts are included solely for the convenience of readers outside Japan and have been made at the rate of ¥108.83 to \$1, the approximate rate of exchange at March 31, 2020. Such translations should not be construed as representations that the Japanese yen amounts could be converted into U.S. dollars at that or any other rate.

## 2. SUMMARY OF SIGNIFICANT ACCOUNTING POLICIES

**a. Consolidation**—The consolidated financial statements as of March 31, 2020, include the accounts of the Company and its 11 subsidiaries, including mainly "Denyo Kosan Co., Ltd.," "Nishihatsu Co., Ltd.," "Denyo America Corporation," "Denyo Manufacturing Corporation," "Denyo Asia Pte. Ltd.," "Denyo United Machinery Pte. Ltd.," "Denyo Europe B.V.," "Denyo Vietnam Co., Ltd." and "P.T. Dein Prima Generator" (together, the "Group").

Under the control and influence concepts, those companies in which the Company, directly or indirectly, is able to exercise control over operations are fully consolidated, and those companies over which the Group has the ability to exercise significant influence are accounted for by the equity method.

The investment in "New Japan Machinery Corporation," an associated company, is accounted for by the equity method.

All significant intercompany balances and transactions have been eliminated in consolidation. All material unrealized profit included in assets resulting from transactions within the Group is also eliminated.

"Denyo America Corporation," "Denyo Manufacturing Corporation," "Denyo Asia Pte. Ltd.," "Denyo United Machinery Pte. Ltd.," "Denyo Europe B.V.," "Denyo Vietnam Co., Ltd." and "P.T. Dein Prima Generator" and two other subsidiaries were consolidated using the financial statements as of December 31 because the difference between the fiscal year end date of the subsidiaries and that of the Company does not exceed three months. Significant transactions between December 31 and March 31 are reflected in the accompanying consolidated financial statements.

**b. Unification of Accounting Policies Applied to Foreign Subsidiaries for the Consolidated Financial Statements**—Under Accounting Standards Board of Japan ("ASBJ") Practical Issues Task Force ("PITF") No. 18, "Practical Solution on Unification of Accounting Policies Applied to Foreign Subsidiaries for the Consolidated Financial Statements," the accounting policies and procedures applied to a parent company and its subsidiaries for similar transactions and events under similar circumstances should in principle be unified for the preparation of the consolidated financial statements. However, financial statements prepared by foreign subsidiaries in accordance with either International Financial Reporting Standards or generally accepted accounting principles in the United States of America (Financial Accounting Standards Board Accounting Standards Codification) tentatively may be used for the consolidation process, except for the following items that should be adjusted in the consolidation process so that net income is accounted for in accordance with Japanese GAAP, unless they are not material: (a) amortization of goodwill; (b) scheduled amortization of actuarial gain or loss of pensions that has been recorded in equity through other comprehensive income; (c) expensing capitalized development costs of R&D; and (d) can-

cellation of the fair value model of accounting for property, plant and equipment and investment properties and incorporation of the cost model of accounting; and (e) recording a gain or loss through profit or loss on the sale of an investment in an equity instrument for the difference between the acquisition cost and selling price, and recording impairment loss through profit or loss for other than temporary declines in the fair value of an investment in an equity instrument, where a foreign associate elects to present in other comprehensive income subsequent changes in the fair value of an investment in an equity instrument.

**c. Cash and Cash Equivalents**—Cash and cash equivalents include cash on hand, bank deposits able to be withdrawn on demand and short-term investments with an original maturity of three months or less and are exposed to insignificant risk of fluctuations in value.

**d. Marketable and Investment Securities**—Marketable and investment securities are classified and accounted for depending on management's intent. Available-for-sale securities are reported at fair value, with unrealized gains and losses, net of applicable taxes, reported in a separate component of equity.

Nonmarketable available for sale securities are stated at cost determined by the moving average method. For other-than-temporary declines in fair value, investment securities are reduced to net realizable value by a charge to income.

**e. Allowance for Doubtful Accounts**—The allowance for doubtful accounts is stated in amounts considered to be appropriate based on the Company's past credit loss experience and an evaluation of potential losses in the receivables outstanding.

**f. Inventories**—Inventories are stated at the lower of cost, determined by the first-in, first-out method for finished products and work in process, and by the average method for raw materials, or net selling value.

**g. Property, Plant and Equipment**—Property, plant and equipment are stated at cost. Depreciation of property, plant and equipment of the Company and its consolidated domestic subsidiaries is computed by the declining-balance method based on the estimated useful lives of the assets, while the straight line method is applied to buildings of the Company and its consolidated domestic subsidiaries acquired on or after April 1, 1998, building improvements and structures of the Company and its consolidated domestic subsidiaries acquired on or after April 1, 2016, and all property, plant and equipment of consolidated foreign subsidiaries. The range of useful lives is principally from 7 to 47 years for buildings and structures, and from 2 to 12 years for machinery and equipment.

**h. Long-Lived Assets**—The Group reviews its long-lived assets for impairment whenever events or changes in circumstance indicate the carrying amount of an asset or asset group may not

be recoverable. An impairment loss is recognized if the carrying amount of an asset or asset group exceeds the sum of the undiscounted future cash flows expected to result from the continued use and eventual disposition of the asset or asset group. The impairment loss would be measured as the amount by which the carrying amount of the asset exceeds its recoverable amount, which is the higher of the discounted cash flows from the continued use and eventual disposition of the asset or the net selling price at disposition.

- i. Provision for Product Warranties**—The provision for product warranties is recorded to provide for future potential costs, such as costs related to after sales services within the warranty period based on past experience.
- j. Accrued Bonuses**—Accrued bonuses to employees are provided for at the estimated amounts that the Company and its domestic subsidiaries are obligated to pay to employees after the fiscal year-end, based on services provided during the current period.
- k. Retirement and Pension Plans**—The Company, its domestic subsidiaries and a certain foreign subsidiary maintain defined benefit pension plans. Some foreign subsidiaries maintain defined contribution pension plans.

The Company accounts for the liability for retirement benefits based on the projected benefit obligations and plan assets at the balance sheet date. The projected benefit obligations are attributed to periods on a benefit formula basis.

The unrecognized actuarial gains and losses are amortized on a straight-line basis over a period of 5 years, no longer than the expected average remaining service period of the employees, from the year incurred. Actuarial gains and losses that are yet to be recognized in profit or loss are recognized within equity (accumulated other comprehensive income), after adjusting for tax effects.

- l. Employee Stockownership Plan**—In accordance with PITF No. 30, "Practical Solution on Transactions of Delivering the Company's Own Stock to Employees etc. through Trusts," upon transfer of treasury stock to the employee stockownership trust (the "Trust") by the entity, any difference between the book value and fair value of the treasury stock is recorded in capital surplus. At year-end, the Company records (1) the Company stock held by the Trust as treasury stock in equity, (2) all other assets and liabilities of the Trust on a line-by-line basis, and (3) a liability/asset for the net of (i) any gain or loss on delivery of the stock by the Trust to the employees shareholding association, (ii) dividends received from the entity for the stock held by the Trust, and (iii) any expenses relating to the Trust.
- m. Research and Development Costs**—Research and development costs are charged to income as incurred.
- n. Leases**—In March 2007, the ASBJ issued ASBJ Statement No. 13, "Accounting Standard for Lease Transactions," which revised the previous accounting standard for lease transactions.

Under the previous accounting standard, finance leases that were deemed to transfer ownership of the leased property to the lessee were capitalized. However, other finance leases were permitted to be accounted for as operating lease transactions if certain "as if capitalized" information was disclosed in the notes to the lessee's financial statements. The revised accounting standard requires that all finance lease transactions be capitalized by recognizing lease assets and lease obligations in the balance sheet. In addition, the revised accounting standard permits leases that existed at the transition date and that do not transfer ownership of the leased property to the lessee to continue to be accounted for as operating lease transactions.

The Company applied the revised accounting standard effective April 1, 2008.

All other leases are accounted for as operating leases.

- o. Bonuses to Directors and Audit & Supervisory Board Members**—Bonuses to directors and Audit & Supervisory Board members are accrued at the end of the year to which such bonuses are attributable.

**p. Income Taxes**—The provision for income taxes is computed based on the pretax income included in the consolidated statement of income and comprehensive income. The asset and liability approach is used to recognize deferred tax assets and liabilities for the expected future tax consequences of temporary differences between the carrying amounts and the tax bases of assets and liabilities. Deferred taxes are measured by applying currently enacted income tax rates to the temporary differences.

- q. Foreign Currency Transactions**—All short-term and long-term monetary receivables and payables denominated in foreign currencies are translated into Japanese yen at the exchange rates at the balance sheet date. The foreign exchange gains and losses from translation are recognized in the accompanying consolidated statement of income and comprehensive income.

**r. Foreign Currency Financial Statements**—The balance sheet accounts of the consolidated foreign subsidiaries are translated into Japanese yen at the current exchange rate as of the balance sheet date except for equity, which is translated at the historical rate. Differences arising from such translation are shown as "Foreign currency translation adjustments" under accumulated other comprehensive income in a separate component of equity. Revenue and expense accounts of consolidated foreign subsidiaries are translated into Japanese yen at the average exchange rate.

- s. Derivatives and Hedging Activities**—The Group uses derivative financial instruments to manage its exposures to fluctuations in foreign exchange, interest rates and raw material costs. Foreign exchange forward contracts, currency swaps, interest rate swaps and commodity swaps are utilized by the Group to reduce the risk of fluctuation of foreign currency exchange, interest rate and raw material costs. The Group does not enter into derivatives for trading or speculative purposes.

Derivative financial instruments are classified and accounted for as follows: (a) all derivatives, except for those that qualify for hedge accounting, are recognized as either assets or liabilities and measured at fair value, and gains or losses on derivative transactions are recognized in the income statement and (b) for derivatives used for hedging purposes, if derivatives qualify for hedge accounting because of high correlation and effectiveness between the hedging instruments and the hedged items, gains or losses on derivatives are deferred until maturity of the hedged transactions.

Interest rate swaps which qualify for hedge accounting and meet specific matching criteria are not remeasured at market value but the differential paid or received under the swap agreements is recognized and included in interest expense.

The commodity swaps which qualify for hedge accounting are measured at market value at the balance sheet date and the unrealized gains or losses are deferred until maturity as deferred gain (loss) on derivatives under hedge accounting as a separate component of equity.

- t. Per Share Information**—Basic net income per share is computed by dividing net income attributable to common shareholders by the weighted-average number of common shares outstanding for the period, retroactively adjusted for stock splits.

Cash dividends per share presented in the accompanying consolidated statement of income and comprehensive income are dividends applicable to the respective fiscal years, including dividends to be paid after the end of the year.

- u. Consumption Taxes**—Consumption taxes are not included in sales, cost of sales and selling, general and administrative expenses, etc.

## v. New Accounting Pronouncements

As a result, in the consolidated statement of balance sheet for the year ended March 31, 2019, "Other assets" under "Investments and other assets" increased by ¥293 million, "Other" under "Current liabilities" increased by ¥14 million, and "Long-term debt" under "Long term liabilities" increased by ¥282 million. And the opening balance of "Retained earnings" decreased by ¥3 million.

**Accounting Standard for Revenue Recognition**—On March 30, 2018, the ASBJ issued ASBJ Statement No. 29, "Accounting Standard for Revenue Recognition," and ASBJ Guidance No. 30, "Implementation Guidance on Accounting Standard for Revenue Recognition." The core principle of the standard and guidance is that an entity should recognize revenue to depict the transfer of promised goods or services to customers in an amount that reflects the consideration to which the entity expects to be entitled in exchange for those goods or services. An entity should recognize revenue in accordance with that core principle by applying the following steps:

- Step 1: Identify the contract(s) with a customer
- Step 2: Identify the performance obligations in the contract
- Step 3: Determine the transaction price
- Step 4: Allocate the transaction price to the performance obligations in the contract
- Step 5: Recognize revenue when (or as) the entity satisfies a performance obligation

The accounting standard and guidance are effective for annual periods beginning on or after April 1, 2021. Earlier application is permitted for annual periods beginning on or after April 1, 2018.

The Company expects to apply the accounting standard and guidance for annual periods beginning on April 1, 2021, and is in the process of measuring the effects of applying the accounting standard and guidance in future applicable periods.

- Accounting Standard for Fair Value Measurement (ASBJ Statement No. 30, July 4, 2019)
- Implementation Guidance on Accounting Standard for Fair Value Measurement (ASBJ Guidance No. 31, July 4, 2019)
- Accounting Standard for Measurement of Inventories (ASBJ Guidance No. 9, July 4, 2019)
- Accounting Standard for Financial Instruments (ASBJ Guidance No. 10, July 4, 2019)
- Implementation Guidance on Disclosures about Fair Value of Financial Instruments (ASBJ Guidance No. 19, March 31, 2020)

### (1) Overview

To improve comparability with international accounting standards, the "Accounting Standard for Fair Value Measurement" and "Implementation Guidance on Accounting Standard for Fair Value Measurement" (hereinafter, "Fair Value Measurement Accounting Standards") were developed, establishing guidance and other information on how to calculate market prices. Fair Value Measurement Accounting Standards are applied to the market prices of the following items.

- Financial instruments within the "Accounting Standard for Financial Instruments"
  - Inventory assets held for the purpose of trading within the "Accounting Standard for Measurement of Inventories"
- Additionally, "Guidance on Disclosures about Fair Value of Financial Instruments" was revised and notes, including a breakdown by the market value level of financial instruments, were established.

### (2) Scheduled date of adoption

This standard will be adopted from the beginning of the fiscal year ending March 31, 2022.

### (3) Impact of adopting this accounting standard

At the time these consolidated financial statements were prepared, the material impact of the adoption of this accounting standard had not yet been determined.

- Accounting Standard for Disclosure of Accounting Estimates (ASBJ Guidance No. 31, March 31, 2020)

#### (1) Overview

As the purpose of this standard is to disclose information that contributes to the understanding among users of financial statements, this addresses figures recorded in the financial statements for the current fiscal year based on accounting estimates for items that have a risk of a significantly impacting financial statements in the next fiscal year.

#### (2) Scheduled date of adoption

This standard will be adopted from the end of the fiscal year ending March 31, 2021.

- Accounting Standard for Accounting Policy Disclosures, Accounting Changes and Error Corrections (ASBJ Guidance No. 24, March 31, 2020)

#### (1) Overview

This guidance is intended to provide an overview of the accounting principles and procedures adopted when the relevant accounting standards are not clear.

#### (2) Scheduled date of adoption

This standard will be adopted from the end of the fiscal year ending March 31, 2021.

- w. Change in Disclosures**—"Electronically recorded monetary claims—operating" which had been included in the "Trade notes" in "Current assets" in the consolidated statement of balance sheet for the year ended March 31, 2019, and "Electronically recorded obligations—operating" which had been included in the "Trade notes" in "Current liabilities" in the consolidated statement of balance sheet for the year ended March 31, 2019, were presented as separate line items for the year ended March 31, 2020, due to increase in materiality.

As a result, the amount of ¥8,973 million disclosed as "Trade notes" under "Current assets" in the consolidated statement of balance sheet for the year ended March 31, 2019, has been reclassified as ¥3,294 million under "Electronically recorded monetary claims—operating" and as ¥5,679 million under "Trade notes." And the amount of ¥3,399 million disclosed as "Trade notes" under "Current liabilities" in the consolidated statement of balance sheet for the year ended March 31, 2019, has been reclassified as ¥2,146 million under "Electronically recorded obligations—operating" and as ¥1,253 million under "Trade notes."

"Insurance claim income" which had been included in the "Other—net" in "Other income (expenses)" in the consolidated statement of income and comprehensive income for the year ended March 31, 2019, was presented as separate line items for the year ended March 31, 2020, due to increase in materiality.

As a result, the amount of ¥26 million disclosed as "Other—net" under "Other income (expenses)" in the consolidated statement of income and comprehensive income for the year ended March 31, 2019, has been reclassified as ¥3 million under "Insurance claim income" and as ¥23 million under "Other—net."

"Proceeds from sales of property, plant and equipment" which were disclosed under "Investing activities" in the consolidated statement of cash flows for the year ended March 31, 2019, have been disclosed as "Other—net" for the year ended March 31, 2020, due to decrease in materiality.

As a result, the amount of ¥5 million disclosed as "Proceeds from sales of property, plant and equipment" under "Investing activities" in the consolidated statement of cash flows for the year ended March 31, 2019, has been reclassified as ¥(50) million under "Other—net."

### 3. ACCOUNTING CHANGE

**IFRS 16 Leases**—IFRS 16 sets out the principles for recognition, measurement, presentation, and disclosure of leases. A lessee is required to account for all leases in its consolidated statement of financial position, applying a single accounting model. IFRS 16 is effective for annual periods beginning on or after January 1, 2019,

and some foreign subsidiaries have applied IFRS 16 from January 1, 2019. Some foreign subsidiaries apply transition requirements in IFRS 16 that retrospectively recognize the cumulative effect of initially applying the standard as an adjustment to the opening balance of retained earnings at the date of initial application.

### 4. STOCK GRANTING TRUST ("J-ESOP" and "BBT")

The Company has introduced a Stock Granting Trust ("J-ESOP") for the purpose of enhancing the benefits package to employees and providing incentives for raising corporate value.

The Company grants employees points according to their continued services and results, and when the employees retire, the Company delivers to them its own stock (or pays an equivalent amount in cash) corresponding to the number of their accumulated points through the Trust.

The Company has introduced a new stock compensation plan for directors called the "Board Benefit Trust (BBT)" since September 1, 2015. The Company grants its directors points according to the Company's business results, etc., and the Company delivers to the directors who have beneficiary rights its own stock corresponding to the number of their accumulated points determined on a given date every year through the Trust.

These Trusts held treasury stock as follows which was included in the balance sheet of the Company:

	Millions of Yen		Thousands of U.S. Dollars
	2020	2019	2020
Treasury stock.....	¥492	¥511	\$4,524
(Number of shares (thousands of shares)) .....	(775)	(792)	

### 5. MARKETABLE AND INVESTMENT SECURITIES

Marketable and investment securities as of March 31, 2020 and 2019, consisted of the following:

	Millions of Yen		Thousands of U.S. Dollars
	2020	2019	2020
Non-current:			
Marketable equity securities.....	¥5,625	¥7,166	\$51,685
Nonmarketable equity securities.....	893	998	8,204
Total.....	¥6,518	¥8,164	\$59,889

The cost and aggregate fair values of marketable and investment securities at March 31, 2020 and 2019, were as follows:

	Millions of Yen			
	Cost	Unrealized Gains	Unrealized Losses	Fair Value
<b>March 31, 2020</b>				
Securities classified as available-for-sale—				
Equity securities.....	¥1,950	¥3,687	¥12	¥5,625
<b>March 31, 2019</b>				
Securities classified as available-for-sale—				
Equity securities.....	¥2,216	¥4,951	¥1	¥7,166
	Thousands of U.S. Dollars			
	Cost	Unrealized Gains	Unrealized Losses	Fair Value
<b>March 31, 2020</b>				
Securities classified as available-for-sale—				
Equity securities.....	\$17,915	\$33,881	\$111	\$51,685

The proceeds, realized gains and realized losses of the available-for-sale securities which were sold during the years ended March 31, 2020 and 2019, were as follows:

	Millions of Yen		
	Proceeds	Realized Gains	Realized Loss
<b>March 31, 2020</b>			
Available-for-sale—Equity securities .....	¥390	¥218	¥22
<b>March 31, 2019</b>			
Available-for-sale—Equity securities .....	¥266	¥122	¥1

	Thousands of U.S. Dollars		
	Proceeds	Realized Gains	Realized Loss
<b>March 31, 2020</b>			
Available-for-sale—Equity securities .....	\$3,585	\$2,004	\$207

The impairment losses on available-for-sale equity securities for the year ended March 31, 2020, was ¥180 million (\$1,657 thousand).

## 6. INVENTORIES

Inventories at March 31, 2020 and 2019, consisted of the following:

	Millions of Yen		Thousands of U.S. Dollars
	2020	2019	2020
Finished products and merchandise .....	¥3,920	¥4,258	\$36,021
Work in process .....	1,410	1,237	12,950
Raw materials and supplies .....	5,144	5,153	47,268
Total .....	¥10,474	¥10,648	\$96,239

## 7. LONG-LIVED ASSETS

The Group reviewed its long-lived assets for impairment as of March 31, 2019. As a result, the Group recognized an impairment loss of ¥108 million as loss on impairment of long-lived assets for an employee dormitory following the decision to abolish and demolish it and the carrying amount of the relevant buildings and

leasehold rights was written down to the recoverable amount. The recoverable amount was measured using the net realizable value based on the selling price and evaluated at ¥0. No impairment loss was recognized in 2020.

## 8. INVESTMENTS IN ASSOCIATED COMPANIES

Investments in associated companies at March 31, 2020 and 2019, were as follows:

	Millions of Yen		Thousands of U.S. Dollars
	2020	2019	2020
Investments—New Japan Machinery Corporation .....	¥811	¥940	\$7,454
Total .....	¥811	¥940	\$7,454

## 9. SHORT-TERM BANK LOANS AND LONG-TERM DEBT

Short-term bank loans at March 31, 2020 and 2019, consisted of bank overdrafts. The weighted-average interest rate applicable to the short-term bank loans was 0.5% and 1.9% at March 31, 2020 and 2019.

Long-term debt at March 31, 2020 and 2019, consisted of the following:

	Millions of Yen		Thousands of U.S. Dollars
	2020	2019	2020
Unsecured loans from banks, with interest rate at 3.4% (2020 and 2019)	¥1,088	¥1,110	\$10,000
Obligations under finance leases	298	2	2,734
Total	1,386	1,112	12,734
Less current portion	(15)	(1)	(137)
Long-term debt, less current portion	¥1,371	¥1,111	\$12,597

Annual maturities of long term debt at March 31, 2020, were as follows:

Year Ending March 31	Millions of Yen	Thousands of U.S. Dollars
2021	¥15	\$137
2022	1,101	10,114
2023	13	117
2024	13	119
2025	14	129
2026 and thereafter	230	2,118
Total	¥1,386	\$12,734

## 10. COMMITMENT LINE CONTRACTS

In order to raise funds efficiently, the Company has entered into a commitment line contract with four financial institutions, of which Mizuho Bank, Ltd. is the arranger. The contract provided the Company

with a commitment line of ¥3,000 million (\$27,566 thousand) as of March 31, 2020. The Company had no borrowings outstanding under the agreement as of March 31, 2020.

## 11. RETIREMENT AND PENSION PLANS

The Company has a defined benefit pension plan and domestic subsidiaries also participate in the same plan. A certain foreign subsidiary has its own defined benefit pension plan and other foreign subsidiaries have defined contribution plans. In addition, the Company and domestic subsidiaries have a stock granting retirement plan.

The projected benefit obligation of a certain domestic subsidiary is calculated using a simplified method, which is permitted for small companies in accordance with the accounting standard for retirement benefits.

(1) The changes in defined benefit obligation for the years ended March 31, 2020 and 2019, were as follows:

	Millions of Yen		Thousands of U.S. Dollars
	2020	2019	2020
Balance at beginning of year	¥2,865	¥2,905	\$26,327
Current service cost	168	169	1,541
Interest cost	24	23	221
Actuarial losses (gains)	19	(8)	170
Benefits paid	(302)	(213)	(2,772)
Others	5	(11)	47
Balance at end of year	¥2,779	¥2,865	\$25,534

(2) The changes in plan assets for the years ended March 31, 2020 and 2019, were as follows:

	Millions of Yen		Thousands of U.S. Dollars
	2020	2019	2020
Balance at beginning of year .....	¥2,575	¥2,552	\$23,662
Expected return on plan assets .....	30	30	280
Actuarial losses .....	(6)	(2)	(53)
Contributions from the employer .....	187	188	1,718
Benefits paid .....	(295)	(194)	(2,712)
Others .....	3	1	25
Balance at end of year .....	¥2,494	¥2,575	\$22,920

(3) Reconciliation between the liability recorded in the consolidated balance sheet and the balances of defined benefit obligation and plan assets was as follows:

	Millions of Yen		Thousands of U.S. Dollars
	2020	2019	2020
Funded defined benefit obligation .....	¥2,698	¥2,780	\$24,788
Plan assets .....	2,494	2,575	22,920
Total .....	204	205	1,868
Unfunded defined benefit obligation .....	81	85	745
Liability for stock granting retirement .....	149	143	1,374
Net liability arising from defined benefit obligation .....	¥433	¥433	\$3,987

	Millions of Yen		Thousands of U.S. Dollars
	2020	2019	2020
Liability for retirement benefits .....	¥434	¥433	\$3,987
Net liability arising from defined benefit obligation .....	¥434	¥433	\$3,987

(4) The components of net periodic benefit costs for the years ended March 31, 2020 and 2019, were as follows:

	Millions of Yen		Thousands of U.S. Dollars
	2020	2019	2020
Service cost .....	¥168	¥169	\$1,541
Interest cost .....	24	23	220
Expected return on plan assets .....	(30)	(30)	(279)
Recognized actuarial losses .....	17	22	157
Stock granting cost .....	37	46	348
Net periodic benefit costs .....	¥216	¥230	\$1,978

(5) Amounts recognized in other comprehensive income (before income tax effect) in respect of defined retirement benefit plans for the years ended March 31, 2020 and 2019, were as follows:

	Millions of Yen		Thousands of U.S. Dollars
	2020	2019	2020
Actuarial gains .....		¥12	

(6) Amounts recognized in accumulated other comprehensive income (before income tax effect) in respect of defined retirement benefit plans as of March 31, 2020 and 2019, were as follows:

	Millions of Yen		Thousands of U.S. Dollars
	2020	2019	2020
Unrecognized actuarial gains .....	¥(47)	¥(47)	\$(435)

## (7) Plan assets

*a. Components of plan assets*

Plan assets as of March 31, 2020 and 2019, consisted of the following:

	2020	2019
General account managed by a life insurance company .....	100.0%	100.0%
Total .....	100.0%	100.0%

*b. Method of determining the expected rate of return on plan assets*

The expected rate of return on plan assets is determined considering the long-term rates of return which are expected currently and in the future from the various components of the plan assets.

## (8) Assumptions used for the years ended March 31, 2020 and 2019, are set forth as follows:

	2020	2019
Discount rate .....	Mainly 0.60%	Mainly 0.60%
Expected rate of return on plan assets .....	Mainly 1.25%	Mainly 1.25%
Expected rate of future salary increase .....	Mainly 1.90%	Mainly 1.90%

**12. EQUITY**

Japanese companies are subject to the Companies Act of Japan (the "Companies Act"). The significant provisions in the Companies Act that affect financial and accounting matters are summarized below:

*a. Dividends*

Under the Companies Act, companies can pay dividends at any time during the fiscal year in addition to the year-end dividend upon resolution at the shareholders' meeting. Additionally, for companies that meet certain criteria including (1) having a Board of Directors, (2) having independent auditors, (3) having an Audit & Supervisory Board, and (4) the term of service of the directors being prescribed as one year rather than the normal two-year term by its articles of incorporation, the Board of Directors may declare dividends (except for dividends-in-kind) at any time during the fiscal year if the company has prescribed so in its articles of incorporation. The Company meets all the above criteria.

The Companies Act permits companies to distribute dividends-in-kind (noncash assets) to shareholders subject to a certain limitation and additional requirements.

Semiannual interim dividends may also be paid once a year upon resolution by the Board of Directors if the articles of incorporation of the company so stipulate. The Companies Act provides certain limitations on the amounts available for dividends or the purchase of treasury stock. The limitation is defined as the amount available for distribution to the shareholders, but the amount of net assets after dividends must be maintained at no less than ¥3 million.

*b. Increases/Decreases and Transfer of Common Stock, Reserve and Surplus*

The Companies Act requires that an amount equal to 10% of dividends must be appropriated as a legal reserve (a component of retained earnings) or as additional paid-in capital (a component of capital surplus), depending on the equity account charged upon the payment of such dividends, until the aggregate amount of the legal reserve and additional paid-in capital equals 25% of

the common stock. Under the Companies Act, the total amount of additional paid-in capital and legal reserve may be reversed without limitation. The Companies Act also provides that common stock, legal reserve, additional paid-in capital, other capital surplus and retained earnings can be transferred among the accounts within equity under certain conditions upon resolution of the shareholders.

*c. Treasury Stock and Treasury Stock Acquisition Rights*

The Companies Act also provides for companies to purchase treasury stock and dispose of such treasury stock by resolution of the Board of Directors. The amount of treasury stock purchased cannot exceed the amount available for distribution to the shareholders which is determined by a specific formula. Under the Companies Act, stock acquisition rights are presented as a

separate component of equity. The Companies Act also provides that companies can purchase both treasury stock acquisition rights and treasury stock. Such treasury stock acquisition rights are presented as a separate component of equity or deducted directly from stock acquisition rights.

**13. INCOME TAXES**

The Company and its domestic subsidiaries are subject to Japanese national and local income taxes which, in the aggregate, resulted in normal effective statutory tax rates of approximately 30.6% and 30.9% for the years ended March 31, 2020 and 2019, respectively.

The tax effects of significant temporary differences and tax loss carryforwards which resulted in deferred tax assets and liabilities at March 31, 2020 and 2019, are as follows:



	Millions of Yen		Thousands of U.S. Dollars
	2020	2019	2020
Deferred tax assets:			
Accrued bonuses .....	¥190	¥193	\$1,746
Provision for product warranties .....	36	31	328
Accrued enterprises taxes .....	65	37	595
Unrealized gain on sale of inventory .....	79	104	729
Unrealized gain on sale of property .....	22	21	204
Liability for retirement benefits .....	113	115	1,044
Loss on revaluation of investment securities .....	77	22	709
Tax loss carryforwards .....	12	21	110
Other .....	227	237	2,082
Less valuation allowance .....	(120)	(73)	(1,100)
Total .....	701	708	6,447
Deferred tax liabilities:			
Reserve for deferred gains on sales of property .....	346	346	3,184
Unrealized gain on available-for-sale securities .....	1,107	1,498	10,174
Other .....	37	12	337
Total .....	1,490	1,856	13,695
Net deferred tax liabilities .....	¥(789)	¥(1,148)	\$(7,248)

As the difference between the normal effective statutory tax rate and the actual effective tax rate reflected in the accompanying consolidated statement of income and comprehensive income for the year ended March 31, 2020, is less than 5% of the normal effective statutory tax rate, a reconciliation is omitted.

A reconciliation between the normal effective statutory tax rates and the actual effective tax rates reflected in the accompanying consolidated statement of income and comprehensive income for the year ended March 31, 2019, is as follows:

	2019
Normal effective statutory tax rate .....	30.6%
Expenses not deductible for income tax purposes .....	2.0
Income not recognizable for income tax purposes .....	(0.5)
Per capita portion of inhabitants' taxes .....	0.6
Tax credits .....	(2.8)
Lower income tax rates applicable to income in certain foreign countries .....	(1.8)
Valuation allowance .....	(0.5)
Other—net .....	(0.6)
Actual effective tax rate .....	27.0%

At March 31, 2020, some subsidiaries have tax loss carryforwards aggregating approximately ¥54 million (\$497 thousand) which are available to be offset against taxable income of such subsidiaries in future years. These tax loss carryforwards, if not utilized, will expire as follows:

Year Ending March 31	Millions of Yen	Thousands of U.S. Dollars
2021 .....		
2022 .....		
2023 .....	¥50	\$464
2024 .....		
2025 and thereafter .....	4	33
Total .....	¥54	\$497

## 14. RESEARCH AND DEVELOPMENT COSTS

Research and development costs charged to income were ¥585 million (\$5,373 thousand) and ¥588 million for the years ended March 31, 2020 and 2019, respectively.

## 15. LEASES

The Group leases certain vehicles and right of use assets.

Lease payments under finance leases for the years ended March 31, 2020 and 2019, were ¥15 million (\$137 thousand) and ¥1 million, respectively.

Obligations under finance leases were as follows:

	Millions of Yen		Thousands of U.S. Dollars
	2020	2019	2020
Due within one year .....	¥15	¥1	\$137
Due after one year .....	283	1	2,597
Total .....	¥298	¥2	\$2,734

## 16. FINANCIAL INSTRUMENTS AND RELATED DISCLOSURES

### (1) Group Policy for Financial Instruments

The Group invests cash surpluses in low-risk financial assets. Bank loans are used to fund its ongoing operations. Derivatives are not used for speculative purposes, but to manage exposure to financial risks as described in Note 17.

### (2) Nature and Extent of Risks Arising from Financial Instruments

Receivables, such as trade notes and trade accounts, are exposed to customer credit risk. Receivables in foreign currencies are exposed to the market risk of fluctuation in foreign currency exchange rates.

Investment securities, mainly equity instruments of customers and suppliers of the Company, are exposed to the risk of market price fluctuations.

Payment terms of payables, such as trade notes and trade accounts, are almost less than six months. Payables in foreign currencies are exposed to the market risk of fluctuation in foreign currency exchange rates.

Maturities of bank loans are less than five years after the balance sheet date. Although a part of such bank loans is exposed to market risks from changes in variable interest rates, those risks are mitigated by using derivatives of interest rate swaps.

Derivatives mainly include interest rate swaps, commodity swaps, forward foreign currency contracts and currency swap contracts, which are used to manage exposure to market risks from changes in interest rates of bank loans, from changes in raw material (copper) prices, and from changes in foreign currency exchange rates of receivables and advances. Please see Note 17 for more detail about derivatives.

### (3) Risk Management for Financial Instruments

#### Credit risk management

Credit risk is the risk of economic loss arising from a counterparty's failure to repay or service debt according to the contractual terms. The Company manages its credit risk from receivables on the basis of internal guidelines, which include

#### Market risk management (foreign exchange risk and interest rate risk)

Foreign currency trade receivables and payables are exposed to market risk resulting from fluctuations in foreign currency exchange rates. The Group reduces such foreign exchange risk by balancing foreign currency trade receivables and payables. Forward foreign currency contracts and currency swap contracts are used for some foreign currency trade receivables and advances.

Interest rate swaps are used to manage exposure to market risks from changes in interest rates of loan payables and commodity swaps are used to manage exposure to market risks from changes

#### Liquidity risk management

Liquidity risk comprises the risk that the Company cannot meet its contractual obligations in full on maturity dates. The Company manages its liquidity risk by holding an adequate

monitoring of payment terms and balances of major customers by the Sales Planning department to identify the default risk of customers at an early stage. Each consolidated subsidiary also manages its credit risk from receivables by an equivalent method.

in raw material (copper) prices.

The Company continuously reviews portfolios of securities by periodically monitoring fair values of each security and the financial condition of the issuer as well as market conditions and the relationship with the issuer.

In conducting derivative transactions, the division in charge of each derivative transaction follows the internal policies which prescribe the authority and the limit for each transaction. The transaction data is reported to the management meeting on a monthly basis.

volume of liquid assets, along with adequate financial planning by the corporate treasury department.

**(4) Fair Values of Financial Instruments**

Fair values of financial instruments are based on quoted prices in active markets. If a quoted price is not available, other rational valuation techniques are used instead. Additionally, notional

amounts of derivative transactions, which are presented in Note 17, "Derivatives," do not indicate market risk of derivative transactions. Also, please see Note 17 for the details of fair value for derivatives.

**(a) Fair value of financial instruments**

<b>March 31, 2020</b>	<b>Millions of Yen</b>		
	<b>Carrying Amount</b>	<b>Fair Value</b>	<b>Unrealized Loss</b>
Cash and cash equivalents .....	¥21,054	¥21,054	
Receivables .....	21,173	21,173	
Investment securities .....	5,625	5,625	
<b>Total</b> .....	<b>¥47,852</b>	<b>¥47,852</b>	
Short-term bank loans .....	¥210	¥210	
Payables .....	11,076	11,076	
Long-term debt .....	1,386	1,408	¥(22)
<b>Total</b> .....	<b>¥12,672</b>	<b>¥12,694</b>	<b>¥(22)</b>
Derivatives .....	¥(141)	¥(141)	

<b>March 31, 2019</b>	<b>Millions of Yen</b>		
	<b>Carrying Amount</b>	<b>Fair Value</b>	<b>Unrealized Loss</b>
Cash and cash equivalents .....	¥16,171	¥16,171	
Time deposits other than cash equivalents .....	18	18	
Receivables .....	22,829	22,829	
Investment securities .....	7,167	7,167	
<b>Total</b> .....	<b>¥46,185</b>	<b>¥46,185</b>	
Short-term bank loans .....	¥432	¥432	
Payables .....	11,676	11,676	
Long-term debt .....	1,112	1,112	
<b>Total</b> .....	<b>¥13,220</b>	<b>¥13,220</b>	
Derivatives .....	¥(191)	¥(191)	

<b>March 31, 2020</b>	<b>Thousands of U.S. Dollars</b>		
	<b>Carrying Amount</b>	<b>Fair Value</b>	<b>Unrealized Loss</b>
Cash and cash equivalents .....	\$193,460	\$193,460	
Receivables .....	194,553	194,553	
Investment securities .....	51,685	51,685	
<b>Total</b> .....	<b>\$439,698</b>	<b>\$439,698</b>	
Short-term bank loans .....	\$1,930	\$1,930	
Payables .....	101,770	101,770	
Long-term debt .....	12,734	12,936	\$(202)
<b>Total</b> .....	<b>\$116,434</b>	<b>\$116,636</b>	<b>\$(202)</b>
Derivatives .....	\$(1,293)	\$(1,293)	

**Cash and Cash Equivalents and Time Deposits Other Than Cash Equivalents**

The carrying values of cash and cash equivalents and time deposits other than cash equivalents approximate fair value because of their short maturities.

**Investment Securities**

The fair values of investment securities are measured at the quoted market price of the relevant stock exchange for the equity instruments.

Receivables and Payables

The carrying values of receivables and payables approximate fair value because of their short maturities.

Short-Term Bank Loans and Long-Term Debt

The carrying values of short-term bank loans approximate fair value because of their short maturities.

The fair values of long-term debt that includes the current portion of long-term debt are determined by discounting the cash flows related to the debt at the Group's assumed corporate borrowing rate.

Derivatives

Fair value information for derivatives is included in Note 17.

*(b) Carrying amount of financial instruments whose fair value cannot be reliably determined*

	Millions of Yen		Thousands of U.S. Dollars
	2020	2019	2020
Investments in equity instruments that do not have a quoted market price in an active market .....	¥893	¥997	\$8,204

*(5) Maturity Analysis for Financial Assets and Securities with Contractual Maturities*

	Millions of Yen		Thousands of U.S. Dollars	
	Due in One Year or Less	Due after One Year through Five Years	Due in One Year or Less	Due after One Year through Five Years
<b>March 31, 2020</b>				
Cash and cash equivalents .....	¥21,054		\$193,460	
Receivables .....	21,173		194,553	
Total .....	¥42,227		\$388,013	

Please see Note 9 for annual maturities of long-term debt and Note 15 for obligations under finance leases.

**17. DERIVATIVES**

The Group enters into derivatives, in the normal course of business, to reduce the exposure to fluctuations in foreign exchange rates, raw material prices and interest rates. The primary derivative instruments used by the Company are foreign currency forward contracts, currency swap contracts, commodity swaps and interest rate swaps.

It is the Group's policy to use derivatives only for the purpose of reducing market risks associated with assets and liabilities.

Because the counterparties to these derivatives are limited to major international financial institutions, the Group does not anticipate any losses arising from credit risk.

Derivative transactions entered into by the Group have been made in accordance with internal policies which regulate the authorization and credit limit amount.

***Derivative Transactions to Which Hedge Accounting Is Not Applied***

	Millions of Yen				Thousands of U.S. Dollars			
	Contract Amount	Contract Amount Due after One Year	Fair Value	Unrealized Gain/Loss	Contract Amount	Contract Amount Due after One Year	Fair Value	Unrealized Gain/Loss
<b>March 31, 2020</b>								
Foreign currency forward contracts – Selling U.S.\$ .....	¥1,016	¥1,016	¥(53)	¥(53)	\$9,336	\$9,336	\$(491)	\$(491)
Currency swap contracts– Selling U.S.\$ .....	285	285	(87)	(87)	2,617	2,617	(802)	(802)
<b>March 31, 2019</b>								
Foreign currency forward contracts– Selling U.S.\$ .....	¥1,016	¥1,016	¥(15)	¥(15)				
Currency swap contracts– Selling U.S.\$ .....	520	520	(176)	(176)				

**Derivative Transactions to Which Hedge Accounting Is Applied**

	Hedged Item	Thousands of U.S. Dollars	
		Contract Amount	Contract Amount Due after One Year
<b>March 31, 2020</b>			
Interest rate swaps (fixed rate payment, floating rate receipt) .....	Long-term debt	\$10,000	\$10,000
<b>March 31, 2019</b>			
Interest rate swaps (fixed rate payment, floating rate receipt) .....	Long-term debt	\$10,000	\$10,000

The above interest rate swaps which qualify for hedge accounting and meet specific matching criteria are not remeasured at market value, but the differential paid or received under the swap agreements is recognized and included in interest expense or income. In addition, the fair value of such interest rate swaps in Note 16 is included in that of hedged items (i.e., long-term debt).

The fair value of derivative transactions is measured at the quoted price obtained from the financial institution.

The contract or notional amounts of derivatives which are shown in the above table do not represent the amounts exchanged by the parties and do not measure the Group's exposure to credit or market risk.

**18. CONTINGENT LIABILITIES**

At March 31, 2020, the Group had the following contingent liabilities:

	Millions of Yen	Thousands of U.S. Dollars
Export trade bill discounted .....	¥361	\$3,320

**19. OTHER COMPREHENSIVE LOSS**

The components of other comprehensive (loss) income, including reclassification adjustments and tax effects for the years ended March 31, 2020 and 2019, were as follows:

	Millions of Yen		Thousands of U.S. Dollars
	2020	2019	2020
Unrealized loss on available-for-sale securities:			
Losses arising during the year .....	¥(1,237)	¥(1,536)	\$(11,365)
Reclassification adjustments to profit or loss .....	(37)	(121)	(347)
Amount before income tax effect .....	(1,274)	(1,657)	(11,712)
Income tax effect .....	390	505	3,588
Total .....	¥(884)	¥(1,152)	\$(8,124)
Foreign currency translation adjustments—			
Adjustments arising during the year .....	¥(54)	¥(533)	\$(492)
Total .....	¥(54)	¥(533)	\$(492)
Defined retirement benefit plans:			
Adjustments arising during the year .....	¥(0)	¥12	\$(0)
Amount before income tax effect .....	(0)	12	(0)
Income tax effect .....	0	(4)	0
Total .....	¥(0)	¥8	\$(0)
Share of other comprehensive loss in associates—			
Losses arising during the year .....	¥(5)	¥(1)	\$(44)
Total .....	¥(5)	¥(1)	\$(44)
Total other comprehensive loss .....	¥(943)	¥(1,678)	\$(8,660)

**20. NET INCOME PER SHARE**

Basis for the computation of net income per share ("EPS") for the years ended March 31, 2020 and 2019, is as follows:

	Millions of Yen	Thousands of Shares	Yen	U.S. Dollars
	Net Income Attributable to Owners of the Parent	Weighted- Average Shares	EPS	
<b>Year Ended March 31, 2020</b>				
Basic EPS—Net income available to common shareholders ..	¥4,071	20,953	¥194.32	\$1.79
<b>Year Ended March 31, 2019</b>				
Basic EPS—Net income available to common shareholders ..	¥3,167	21,136	¥149.83	

As noted in Note 2.I, the Company applied PITF No. 30, "Practical Solution on Transactions of Delivering the Company's Own Stock to Employees etc. through Trusts." In calculating the number of

weighted-average shares above, the number of shares that are held by the Trust (781 thousand shares in 2020 and 800 thousand shares in 2019) is reflected.

**21. SEGMENT INFORMATION**

Under ASBJ Statement No. 17, "Accounting Standard for Segment Information Disclosures" and ASBJ Guidance No. 20, "Guidance on Accounting Standard for Segment Information Disclosures," an entity is required to report financial and descriptive information about its reportable segments. Reportable segments are operating segments or aggregations of operating segments that meet specified criteria. Operating segments are components of an entity about which

separate financial information is available and such information is evaluated regularly by the chief operating decision maker in deciding how to allocate resources and in assessing performance. Generally, segment information is required to be reported on the same basis as is used internally for evaluating operating segment performance and deciding how to allocate resources to operating segments.

**(1) Description of Reportable Segments**

The Group's reportable segments are those for which separate financial information is available and regular evaluation by the Company's management is being performed in order to decide how resources are allocated among the Group. Therefore, geographic segments of the Group consist of Japan, United States of America, Asia and Europe. Japan includes the Company, "Denyo Kosan Co., Ltd." and "Nishihatsu Co., Ltd." United States of America mainly includes "Denyo Manufacturing Corporation." Asia mainly includes "Denyo United Machinery Pte. Ltd." Europe consists of "Denyo Europe B.V."

**(2) Methods of Measurement for the Amounts of Sales, Profit (Loss), Assets and Other Items for Each Reportable Segment**

The accounting policies of each reportable segment are consistent with those disclosed in Note 2, "Summary of Significant Accounting Policies."

**(3) Information about Sales, Profit (Loss), Assets and Other Items**

	Millions of Yen						
	2020						
	Reportable Segment						
	Japan	United States of America	Asia	Europe	Total	Reconciliations	Consolidated
Sales:							
Sales to external customers .....	¥43,626	¥15,167	¥3,585	¥509	¥62,887		¥62,887
Intersegment sales or transfers .....	4,847	275	4,212	4	9,338	¥(9,338)	
Total .....	¥48,473	¥15,442	¥7,797	¥513	¥72,225	¥(9,338)	¥62,887
Segment profit .....	¥3,396	¥1,169	¥793	¥37	¥5,395	¥663	¥6,058
Segment assets .....	62,490	7,816	10,991	705	82,002	(6,376)	75,626
Other:							
Depreciation and amortization .....	577	241	344	0	1,162		1,162
Investments in associated companies ...	811				811		811
Increase in property, plant and equipment and intangible assets ...	887	294	20		1,201		1,201

	Millions of Yen						
	2019						
	Reportable Segment					Reconciliations	Consolidated
Japan	United States of America	Asia	Europe	Total			
Sales:							
Sales to external customers .....	¥40,711	¥10,893	¥3,314	¥636	¥55,554		¥55,554
Intersegment sales or transfers .....	4,300	317	3,631	4	8,252	¥(8,252)	
Total .....	¥45,011	¥11,210	¥6,945	¥640	¥63,806	¥(8,252)	¥55,554
Segment profit .....	¥2,445	¥755	¥621	¥29	¥3,850	¥351	¥4,201
Segment assets .....	62,147	7,288	10,290	553	80,278	(6,192)	74,086
Other:							
Depreciation and amortization .....	494	172	466		1,132		1,132
Impairment losses of assets .....	108				108		108
Investments in associated companies ..	940				940		940
Increase in property, plant and equipment and intangible assets ...	819	672	9		1,500		1,500

	Thousands of U.S. Dollars						
	2020						
	Reportable Segment					Reconciliations	Consolidated
Japan	United States of America	Asia	Europe	Total			
Sales:							
Sales to external customers .....	\$400,860	\$139,368	\$32,941	\$4,678	\$577,847		\$577,847
Intersegment sales or transfers .....	44,541	2,530	38,701	36	85,808	\$(85,808)	
Total .....	\$445,401	\$141,898	\$71,642	\$4,714	\$663,655	\$(85,808)	\$577,847
Segment profit .....	\$31,209	\$10,739	\$7,287	\$342	\$49,577	\$6,088	\$55,665
Segment assets .....	574,201	71,818	100,993	6,482	753,494	(58,590)	694,904
Other:							
Depreciation and amortization .....	5,303	2,213	3,159	1	10,676		10,676
Investments in associated companies ..	7,454				7,454		7,454
Increase in property, plant and equipment and intangible assets ...	8,151	2,699	188		11,038		11,038

## Related Information

### (1) Information about Products and Services

Information about products and services for the years ended March 31, 2020 and 2019, is omitted since sales to external customers in a single product line (generators, welders, compressors, and other related products) accounted for more than 90% of the total consolidated sales.

### (2) Information about Geographical Areas

Sales to external customers and property, plant and equipment by geographical areas for the years ended March 31, 2020 and 2019, are summarized as follows:

	Millions of Yen				
	2020				
	Japan	North and Central America	Asia	Other Areas	Total
Sales to external customers .....	¥37,043	¥18,430	¥5,198	¥2,216	¥62,887
Property, plant and equipment .....	9,736	1,736	2,973		14,445

	Millions of Yen				
	2019				
	Japan	North and Central America	Asia	Other Areas	Total
Sales to external customers .....	¥33,693	¥14,080	¥5,528	¥2,253	¥55,554
Property, plant and equipment .....	9,424	1,702	3,288	1	14,415
Impairment losses of assets .....	108				108

	Thousands of U.S. Dollars				
	2020				
	Japan	North and Central America	Asia	Other Areas	Total
Sales to external customers .....	\$340,376	\$169,349	\$47,758	\$20,364	\$577,847
Property, plant and equipment .....	89,456	15,956	27,322		132,734

Note: Sales are classified in countries or regions based on location of customers.

### (3) Information about Major Customers

Sales to major customers for the years ended March 31, 2020 and 2019, are summarized as follows:

Name of Customers	Millions of Yen		Thousands of U.S. Dollars	Related Segment
	2020	2019	2020	
Multiquip Inc. ....	¥15,167	¥10,893	\$139,368	United States of America

## 22. RELATED PARTY TRANSACTIONS

The Company sold its products to New Japan Machinery Corporation, an associated company. The transactions were made with usual terms and conditions.

The transactions with the associates for the years ended March 31, 2020 and 2019, and related balances at March 31, 2020 and 2019, were mainly as follows:

	Millions of Yen		Thousands of U.S. Dollars
	2020	2019	2020
Transactions—Sales .....	¥2,881	¥3,567	\$26,471
Balances:			
Trade notes receivable .....	¥1,421	¥1,782	\$13,059
Trade accounts receivable .....	359	1,088	3,295

## 23. SUBSEQUENT EVENT

### Appropriations of Retained Earnings

The following appropriation of retained earnings at March 31, 2020, was approved at the Company's Board of Directors' meeting held on May 18, 2020:

	Millions of Yen	Thousands of U.S. Dollars
Year-end cash dividends, ¥24 (\$0.22) per share .....	¥520	\$4,778

\* \* \* \* \*



# Independent Auditor's Report

To  
the Board of Directors of Denyo Co., Ltd.

## Opinion

We have audited the consolidated financial statements of Denyo Co., Ltd. and its subsidiaries (the "Group"), which comprise the consolidated balance sheet as of March 31, 2020, and the consolidated statements of income and comprehensive income, consolidated statement of changes in equity and consolidated statement of cash flows for the year then ended, and notes to the consolidated financial statements, including a summary of significant accounting policies, all expressed in Japanese yen.

In our opinion, the accompanying consolidated financial statements present fairly, in all material respects, the consolidated financial position of the Group as of March 31, 2020, and its consolidated financial performance and its consolidated cash flows for the year then ended in accordance with accounting principles generally accepted in Japan.

## Convenience Translation

Our audit also comprehended the translation of Japanese yen amounts into U.S. dollar amounts and, in our opinion, such translation has been made in accordance with the basis stated in Note 1 to the consolidated financial statements. Such U.S. dollar amounts are presented solely for the convenience of readers outside Japan.

## Basis for Opinion

We conducted our audit in accordance with auditing standards generally accepted in Japan. Our responsibilities under those standards are further described in the Auditor's Responsibilities for the Audit of the Consolidated Financial Statements section of our report. We are independent of the Group in accordance with the provisions of the Code of Professional Ethics in Japan, and we have fulfilled our other ethical responsibilities as auditors. We believe that the audit evidence we have obtained is sufficient and appropriate to provide a basis for our opinion.

## Responsibilities of Management and Audit & Supervisory Board Members and the Audit & Supervisory Board for the Consolidated Financial Statements

Management is responsible for the preparation and fair presentation of the consolidated financial statements in accordance with accounting principles generally accepted in Japan, and for such internal control as management determines is necessary to enable the preparation of consolidated financial statements that are free from material misstatement, whether due to fraud or error.

In preparing the consolidated financial statements, management is responsible for assessing the Group's ability to continue as a going concern, disclosing, as applicable, matters related to going concern in accordance with accounting principles generally accepted in Japan and using the going concern basis of accounting unless management either intends to liquidate the Group or to cease operations, or has no realistic alternative but to do so.

Audit & Supervisory Board members and the Audit & Supervisory Board are responsible for overseeing the Directors' execution of duties relating to the design and operating effectiveness of the controls over the Group's financial reporting process.

## Auditor's Responsibilities for the Audit of the Consolidated Financial Statements

Our objectives are to obtain reasonable assurance about whether the consolidated financial statements as a whole are free from material misstatement, whether due to fraud or error, and to issue an auditor's report that includes our opinion. Reasonable assurance is a high level of assurance, but is not a guarantee that an audit conducted in accordance with auditing standards generally accepted in Japan will always detect a material misstatement when it exists. Misstatements can arise from fraud or error and are considered material if, individually or in the aggregate, they could reasonably be expected to influence the economic decisions of users taken on the basis of these consolidated financial statements.

As part of an audit in accordance with auditing standards generally accepted in Japan, we exercise professional judgment and maintain professional skepticism throughout the audit. We also:

- Identify and assess the risks of material misstatement of the consolidated financial statements, whether due to fraud or error, design and perform audit procedures responsive to those risks. The procedures selected depend on the auditor's judgment. In addition, we obtain audit evidence that is sufficient and appropriate to provide a basis for our opinion. The risk of not detecting a material misstatement resulting from fraud is higher than for one resulting from error, as fraud may involve collusion, forgery, intentional omissions, misrepresentations, or the override of internal control.
- Obtain, when performing risk assessment procedures, an understanding of internal control relevant to the audit in order to design audit procedures that are appropriate in the circumstances, but not for the purpose of expressing an opinion on the effectiveness of the Group's internal control.
- Evaluate the appropriateness of accounting policies used and the reasonableness of accounting estimates and related disclosures made by management.
- Conclude on the appropriateness of management's use of the going concern basis of accounting and, based on the audit evidence obtained, whether a material uncertainty exists related to events or conditions that may cast significant doubt on the Group's ability to continue as a going concern. If we conclude that a material uncertainty exists, we are required to draw attention in our auditor's report to the related disclosures in the consolidated financial statements or, if such disclosures are inadequate, to modify our opinion. Our conclusions are based on the audit evidence obtained up to the date of our auditor's report. However, future events or conditions may cause the Group to cease to continue as a going concern.
- Evaluate whether the overall presentation and disclosures of the consolidated financial statements are in accordance with accounting principles generally accepted in Japan, as well as the overall presentation, structure and content of the consolidated financial statements, including the disclosures, and whether the consolidated financial statements represent the underlying transactions and events in a manner that achieves fair presentation.
- Obtain sufficient appropriate audit evidence regarding the financial information of the entities or business activities within the Group to express an opinion on the consolidated financial statements. We are responsible for the direction, supervision and performance of the group audit. We remain solely responsible for our audit opinion.

We communicate with Audit & Supervisory Board members and the Audit & Supervisory Board regarding, among other matters, the planned scope and timing of the audit and significant audit findings, including any significant deficiencies in internal control that we identify during our audit.

We also provide Audit & Supervisory Board members and the Audit & Supervisory Board with a statement that we have complied with relevant ethical requirements regarding independence, and communicate with them all relationships and other matters that may reasonably be thought to bear on our independence, and where applicable, related safeguards.

## Interest Required to Be Disclosed by the Certified Public Accountants Act of Japan

Our firm and its designated engagement partners do not have any interest in the Group which is required to be disclosed pursuant to the provisions of the Certified Public Accountants Act of Japan.

June 26, 2020

*Deloitte Touche Tohmatsu LLC*

Deloitte Touche Tohmatsu LLC

# Company Data

## Company outline (As of March 31, 2020)

Company Name	Denyo Co., Ltd.
Established	July 2, 1948
Head Office	2-8-5, Nihonbashi-horidomecho, Chuo-ku, Tokyo 103-8566, Japan Tel: 81-3-6861-1111 / Fax: 81-3-6861-1181
Paid-in Capital	¥1,954,833,520 (U.S.\$17,962,267)
Authorized shares	97,811,000
Issued Shares	22,859,660
Shareholders	4,297
Financial Year	April 1 to March 31
Employees	569 (1,370 consolidated)
Branch and Sales offices	21

## Directors, Audit Supervisory Board Members (As of June 26, 2020)

President	<b>Shoichi Shiratori</b>	
Representative Director, Executive Vice President	<b>Yoji Eto</b>	Responsible for Global Marketing Office, Production Division, Overseas Manufacturing Subsidiary
Director & Executive Advisor	<b>Hideaki Kuboyama</b>	
Director, Senior Managing Executive Officer	<b>Yasuo Mizuno</b>	Chief Executive, Sales Division Head of International Sales Unit Responsible for Overseas Sales Subsidiary
Director, Managing Executive Officer	<b>Toshiya Tozawa</b>	Chief Executive, Administration Division
Director, Executive Officer	<b>Takanori Yoshinaga</b>	Chief Executive, Development Division
Director, Executive Officer	<b>Masao Yamada</b>	Chief Executive, Quality Management Division
Director	<b>Haruhito Takada*</b>	
Director	<b>Yoshio Takeyama*</b>	
Audit & Supervisory Board Member	<b>Toru Hiroi</b>	
Audit & Supervisory Board Member	<b>Chiyoki Kimura</b>	
Audit & Supervisory Board Member	<b>Akira Yamada*</b>	
Audit & Supervisory Board Member	<b>Keiko Yamagami*</b>	

\*Asterisk\* indicates an external director or external audit & supervisory board member.

## Executive Officers

Managing Executive Officer	<b>Kensaku Moriyama</b>	Deputy Chief Executive, Sales Division, Head of Domestic Sales Unit
Senior Executive Officer	<b>Makoto Tanabe</b>	General Manager, Planning & Coordination Office
Senior Executive Officer	<b>Michio Nonaka</b>	Chief Executive, Production Division
Executive Officer	<b>Yukio Nunogami</b>	General Manager, West Japan Sales Department Sales Division
Executive Officer	<b>Masakazu Minato</b>	General Manager, East Japan Sales Department Sales Division
Executive Officer	<b>Katsumi Ishikura</b>	General Manager, Sales Promotion Department Sales Division
Executive Officer	<b>Noboru Chosei</b>	General Manager, Development Department, Patent Administration Department Development Division
Executive Officer	<b>Shoichi Fujimoto</b>	General Manager, Engineering Department Development Division
Executive Officer	<b>Toshiki Miyamoto</b>	General Manager, Manufacturing Department Production Division
Executive Officer	<b>Kazuyoshi Kubo</b>	General Manager, General Affairs Department, Personnel Department Administration Division
Executive Officer	<b>Kenichi Otomo</b>	General Manager, International Sales Department 1 Sales Division

## Business Lines

Manufacture and sales of:

Generators	Engine-driven Generators Stand-by Generating Sets General-use Generating Sets AC Generators
Welders	Engine-driven Welders Welding Generators Welding Jigs Automatic Welding Equipment
Compressors	Engine-driven Air Compressors Motor-driven Air Compressors
Other Products	Self-propelled Lifters Construction-related Machinery Repair Parts

## Plants and R&D Center

Fukui Plant	Wakasa-cho, Fukui Prefecture
Shiga Plant	Konan, Shiga Prefecture
Laboratory & Training Center	Sakado, Saitama Prefecture



## Denyo Group Companies

### **Denyo Kosan Co., Ltd.**

2-8-5, Nihonbashi-horidomecho, Chuo-ku, Tokyo 103-8566, Japan

**Paid-in Capital:** ¥50 million

**Business:** Services and sales of industrial electrical machinery and parts

### **Nishihatsu Co., Ltd.**

140, Chichika, Karatsu, Saga 847-0831, Japan

**Paid-in Capital:** ¥50 million

**Business:** Manufacture and sales of industrial electrical machinery

### **Denyo America Corporation**

1450 Minor Road, Danville, Kentucky 40422 U.S.A

**Paid-in Capital:** US\$ 5 million

**Business:** Sales of parts for industrial electrical machinery

### **Denyo Manufacturing Corporation**

1450 Minor Road, Danville, Kentucky 40422 U.S.A

**Paid-in Capital:** US\$ 6 million

**Business:** Manufacture and sales of industrial electrical machinery to the U.S. market

### **Denyo Asia Pte. Ltd.**

No.9 Neythal Road, Singapore 628614

**Paid-in Capital:** ¥600 million

**Business:** Sales of industrial electrical machinery

### **Denyo United Machinery Pte. Ltd.**

No.9 Neythal Road, Singapore 628614

**Paid-in Capital:** S\$ 3 million

**Business:** Sales, leasing and rental of industrial electrical machinery

### **Denyo Europe B.V.**

Naamrijk 1, 3454 PX De Meern, The Netherlands

**Paid-in Capital:** €4 million

**Business:** Sales of industrial electrical machinery

### **Denyo Vietnam Co.,Ltd.**

Plot A3, Thang Long Industrial Park II, Lieu Xa Commune, Yen My, Hung Yen, Vietnam

**Paid-in Capital:** US\$ 10 million

**Business:** Manufacture and sales of industrial electrical machinery

### **Denyo Trading Vietnam Co., Ltd.**

Room 606.03, 6th Floor, Indochina Plaza Hanoi Tower, No. 241 Xuan Thuy Street,

Dich Vong Hau Ward, Cau Giay District, Hanoi City, Vietnam

**Paid-in Capital:** US\$ 300 thousand

**Business:** Services and sales of industrial electrical machinery and repair parts

### **P.T. Dein Prima Generator**

JL. Raya Bekasi Km. 28, Medan Satria, Bekasi 17132 Jawa Barat, Indonesia

**Paid-in Capital:** Rp 13,563 million

**Business:** Manufacture and sales of industrial electrical machinery to the Indonesia market

### **New Japan Machinery Corporation**

3-6-5, Shinyokohama, Kohoku-ku, Yokohama, Kanagawa 222-0033, Japan

**Paid-in Capital:** ¥495 million

**Business:** Sales and rental service of industrial electrical machinery

# Investor Information

(As of March 31, 2020)

<b>Head Office</b>	2-8-5, Nihonbashi-horidomecho, Chuo-ku, Tokyo 103-8566, Japan Tel: 81-3-6861-1111 Fax: 81-3-6861-1181
<b>Financial Year</b>	April 1 to March 31
<b>Common Stock</b>	Authorized shares: 97,811,000 Issued shares: 22,859,660 (Included 1,191,596 shares of Company's own stock)
<b>Stock Listing</b>	Tokyo Stock Exchange, First Section (Code: 6517)
<b>Shareholders</b>	4,297
<b>Transfer Agency</b>	Tokyo Securities Transfer Agent Co., Ltd. 3-11, Kanda Nishiki-cho, Chiyoda-ku, Tokyo 101-0054, Japan

## Major Shareholders

(As of March 31, 2020)

<b>Shareholders</b>	<b>Shares Held (Thousands)</b>	<b>Voting Right Ratio (%)</b>
<b>Kyuei Corporation</b>	1,417	6.54
<b>The Master Trust Bank of Japan, Ltd. (Trust Account)</b>	1,199	5.53
<b>Mizuho Trust &amp; Banking Co., Ltd.</b>	1,088	5.02
<b>The Dai-ichi Life Insurance Co., Ltd</b>	872	4.02
<b>Trust &amp; Custody Services Bank, Ltd. (Trust E Account)</b>	774	3.57
<b>Denyo Shin-eikai Group</b>	630	2.91
<b>Japan Trustee Services Bank, Ltd. (Trust Account)</b>	613	2.83
<b>Tsurumi Manufacturing Co., Ltd</b>	543	2.50
<b>MUFG Bank, Ltd.</b>	540	2.49
<b>Kubota Corporation</b>	500	2.31





<http://www.denyo.co.jp>

Head Office

2-8-5, Nihonbashi-horidomecho, Chuo-ku, Tokyo 103-8566, Japan

Tel

81-3-6861-1111

Fax

81-3-6861-1181